

For a perfect climate

The innovative Heating-Cooling- and Lighting range

NEW

BLUETOOTH APP, REMOTE, DIMMER

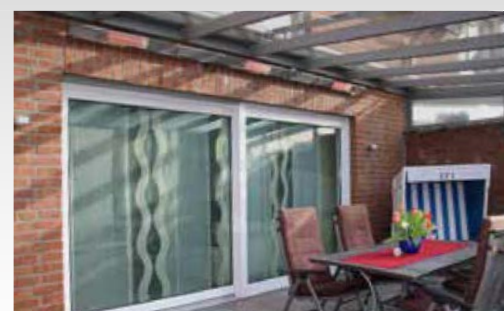

The intelligent solution with short-wave infrared technology

HEATING

As a pioneer in the field of short-wave infrared technology, we now have the benefit of almost 25 years of production experience. Since the early days, our heaters have developed into highly-efficient high-tech systems, used in practically all conceivable areas. Indoors or outdoors for household, commercial, industry and public environments. Permanent or temporary installations, single units to multiple installations. With options of lighting, heat control and our unique cooling systems, you have a solution for virtually all areas and environments.

We have all experienced being exposed to the blistering sun but at dusk it becomes noticeably cooler. It is precisely why we developed PERFECTCLIME®. The unique all-in-one combined heater and cooler. Tried and tested short-wave infrared technology combined with the patented PERFECTCLIME®. This option provides instant cozy heat or pleasant cooling whenever it is required under the motto - PERFECTCLIME at any time.

BURDA
PERFECTCLIME

ALL FROM
SOUL

COOLING

BURDA
WORLDWIDE
TECHNOLOGIES



Our high-quality lighting systems, whether part of a combination or simply as a light bar, have been specifically produced in terms of design and technology to match our heater series for both indoor and outdoor use. The light bars complement our existing heating systems to provide a good-looking, efficient, high-quality and elegant product range. Whether bright workplace lighting or colored illumination at catering outlets or at events, the opportunities are practically limitless.

LIGHTING

BURDA
PERFECTCLIME
SINCE 1990

FROM ONE
SOURCE



QUARTZ INFRA-RED HEATER CONTROLLER

Our complete range of accessories and controllers enables effective, intelligent and especially cost-efficient installations in all kinds of indoor and outdoor areas. Fully automated with the use of timers, dimmers, motion detectors and other sensors as well as a variety of brackets to allow easy installation and use even in larger, more complex projects.

CONTROL



BURDA Perfectclime – the intelligent way



INTELLIGENT SOLUTIONS

As the pioneer in the field of infrared short-wave technology our unique expertise and experience enables us to move the technology forward. The innovative products we offer are the best evidence for intelligent solutions. Producing efficient, energy saving instant heating or cooling products is our passion. Customized solutions, perfectly attuned to people and the environment guarantees an almost unlimited range of uses.

INTELLIGENT ANSWERS

We listen, identify and understand relevant customer needs to find the right answers together. It goes without saying that we are passionate, flexible, customer focused and reliable.

INTELLIGENT REALIZED

Highest standards in the production process and the use of sophisticated materials represent BURDA's claim of always offering its customers only the very best in terms of high quality, design, functionality and high performance. This is the only way possible to set standards worldwide.

INTELLIGENT ADVANTAGES

- Original since 1990
- Unique quality standard
- High quality processing and manufacturing depth
- High quality substance and components
- Increased durability and burning duration
- Efficiency straight to the point
- Emission-free and clean (depending on electricity mix)
- Broad power spectrum up to 18 kW
- Wide choice of colors and models
- High quality elegant design
- Long-lasting, weatherproof aluminum



INTELLIGENT APPLICATIONS



Hotel, bar and catering industry



Sport (swimming pool, golf house, etc.)



Halls (production, warehouse, trade fair, etc.)



Churches



Balcony/terrace/conservatories



Garages/factories



Hangars



Live stock

⚠ Up from 2kW we recommend to use 16A slow blow fuses (C16)

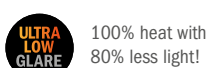

IP20 = Indoor
IP24 = Indoor and Outdoor

IP65 = Outdoor
IP67 = Outdoor

Content

BLUETOOTH	Page 6-7
TERM 2000	Page 8-10
TERM TERM 2500 VOLCANO/TERM 2000 CVH	Page 11
LIGHT & HEAT	Page 12-13
SMART	Page 14-15
PERFECTCLIME	Page 16-17
CONTROL	Page 18-19
ADD ON	Page 20-21
PROMOTION	Page 22
PRODUCT OVERVIEW	Page 23-33
WHAT IS INFRARED?	Page 34
GOOD TO KNOW	Page 35



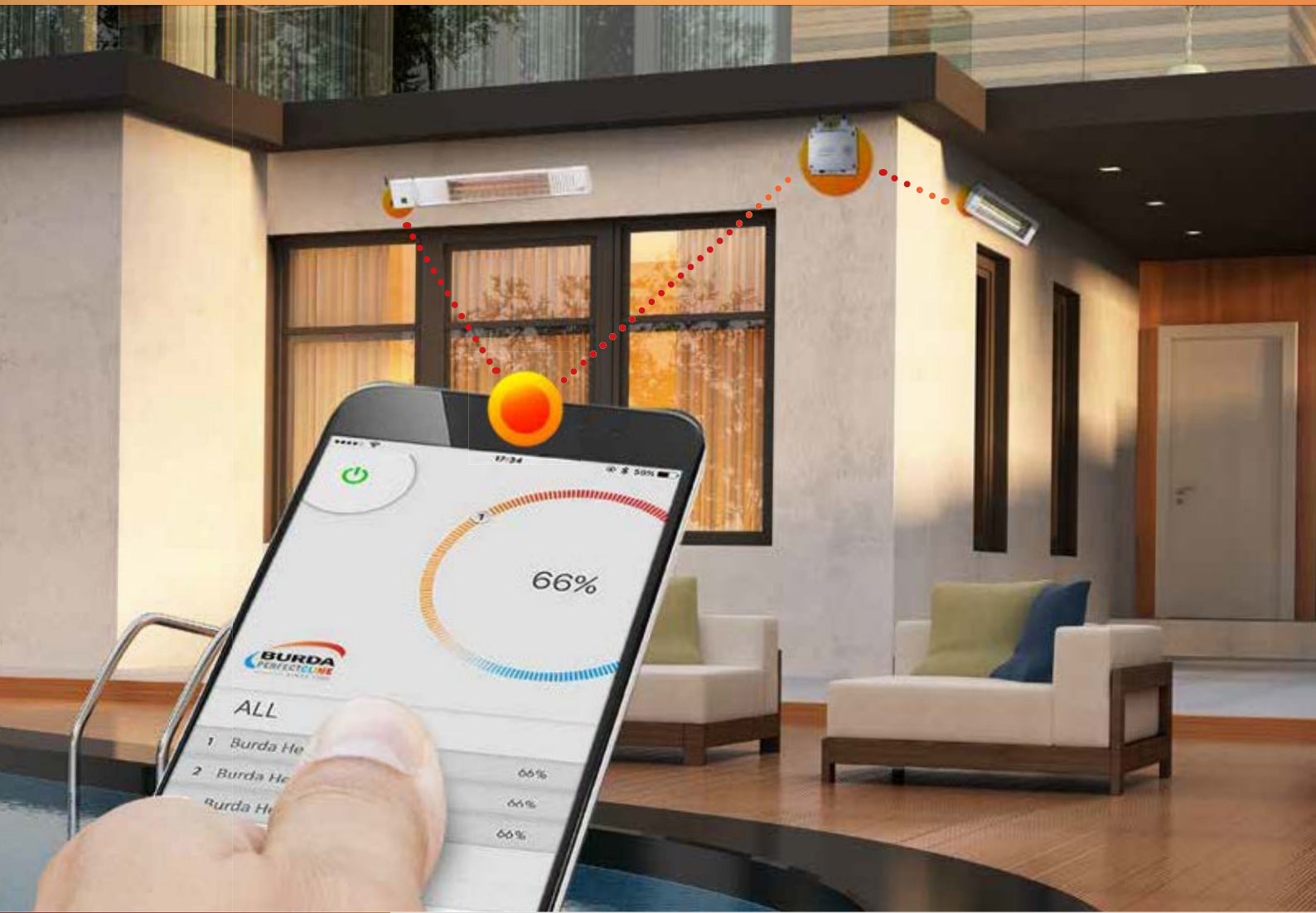

BLUETOOTH

Discover the new Burda Bluetooth products for a wireless regulation via Smartphone with the Burda App! On the one hand we have the Burda **Bluetooth Heater** and on the other hand the Burda **Bluetooth Dimmer** with whom you can control your heaters with the free App or by the inclusive remote control.

APPLICATIONS

Balconies, patios, greenhouses, hobby rooms, hotels, restaurants/cafes

BURDA App Control via Smartphones

NEW



To download the App please scan the QR-Code.

For free for Android and iOS devices.

- ✓ Regulation for up to eight heaters
- ✓ Range: 50 m (no line of sight required)
- ✓ Timer function

NEW · NEW · NEW



Available for Burda Control and Heating systems

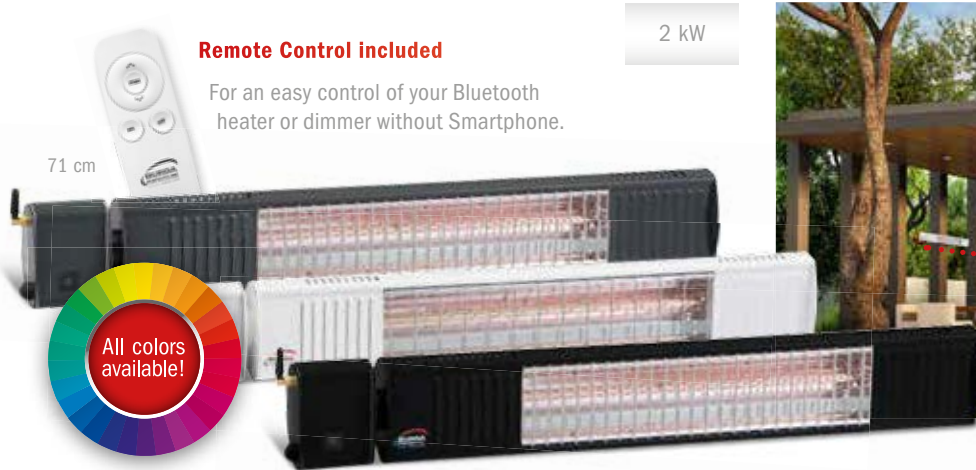

71 cm

Remote Control included

For an easy control of your Bluetooth heater or dimmer without Smartphone.

2 kW



TERM 2000 BLUETOOTH APP & REMOTE



Mounting bracket included (T-Bracket)

- ✓ App control via Smartphone
- ✓ Remote control included
- ✓ Integrated switch for manual operation
- ✓ Colors: Anthracite, white and black
- ✓ Ultra Low Glare
- ✓ IP67



Mounting bracket included (L-Bracket)



2 kW

48 cm

- ✓ **Remote Control included**
For an easy control of your Bluetooth heater or dimmer without Smartphone.
- ✓ App control via Smartphone
- ✓ Integrated switch for manual operation
- ✓ Colors: Silver, white and black

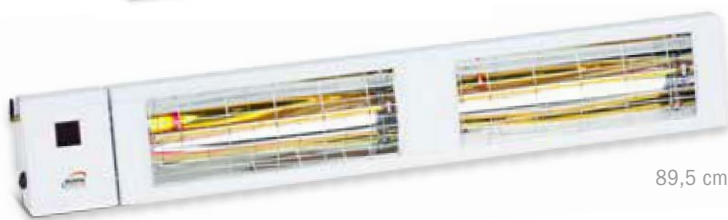

3 kW

89,5 cm

BLUETOOTH SMART IP24

Slow blow fuse 16 Amp (C16) needed



Available from April/May 2017



126 cm

3 kW

BLUETOOTH SMART TOWER IP24

Slow blow fuse 16 Amp (C16) needed



- ✓ Wireless thermoregulation of infrared heater via Smartphone and tablet (iOS & Android) with free Burda APP
- ✓ For Burda heaters and external products
- ✓ Remote control included
- ✓ Integrated switch for manual operation

BLUETOOTH DIMMER IP65



3 kW

1 Channel

Remote Control included

For an easy control of your Bluetooth heater or dimmer without Smartphone.



61 cm

TERM 2000 IP67

Available and combinable with:

PERFECTCLIME



- 1 kW
- 1,5 kW
- 1,65 kW
- 2 kW

Available with
Hirschmann connector

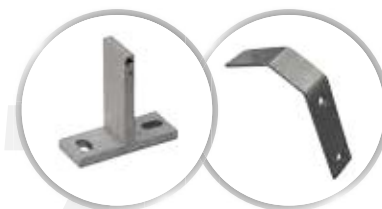

Mounting bracket included
Aluminum-Color-Heater: **T-Bracket**
Aluminum-Heater: **L-Bracket**

TERM 2000

Our TERM 2000 has been designed to provide easy heating of indoor and outdoor areas. It is fitted with a specially developed and manufactured infrared gold tube with a very high operating life of up to 5,000 hours. Depending on the application and the required power output, the TERM 2000 is available in IP24 and IP44 versions, and as a completely waterproof IP67 version. The IP67 is also available as double, triple (IP67 only). All the advantages of the TERM-series are also available as freestanding versions: TERM TOWER PALMS! Ideal for hotels and restaurants, the TERM TOWER PALMS offers optimum heating power for all indoor and outdoor areas – particularly where other systems could not be used because mounting was not possible. There are many different configuration possibilities (i.e. light) which guarantee an infinite field of applications. Also available with table and ashtray.

APPLICATIONS

Restaurants/cafes, hotels, patios, offices, garages, greenhouses, halls, household, churches, public buildings, swimming pools, animal husbandry, workshops, drying-out of buildings



- 3 kW
- 3,3 kW
- 4 kW
- 4,95 kW
- 6 kW

132 cm

TERM 2000 IP67 MULTI

Available and combinable with:

PERFECTCLIME



Available with three emitters



Available with
table and ashtray



TERM TOWER PALMS IP67

Available and combinable with:

PERFECTCLIME





1 kW
1,5 kW

46,4 cm

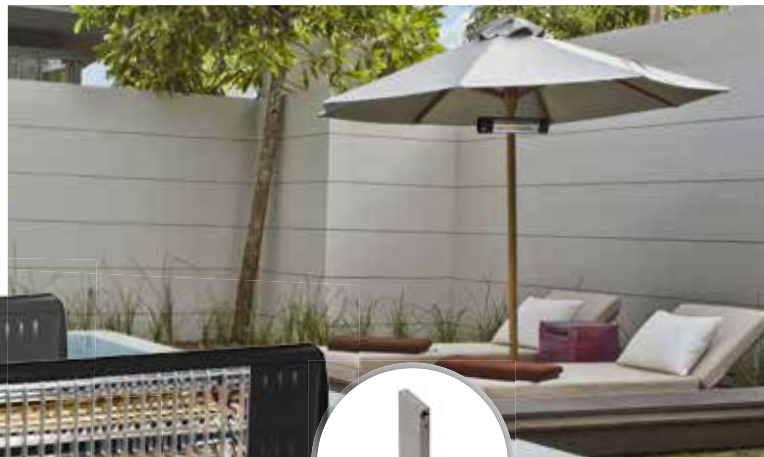

Mounting bracket included (T-Bracket)

TERM 2000 IP44 **ULTRA LOW GLARE**



1 kW
1,5 kW

51 cm



Mounting bracket included (L-Bracket)

TERM 2000 IP24/IP44 **ULTRA LOW GLARE**



1 kW
0,65 kW
1,3 kW
1,95 kW



35,7 cm



60,7 cm



85,5 cm



Mounting bracket included (T-Bracket)

TERM 2000 IP20 NO GLARE **NO GLARE**



TERM 2500 VOLCANO



TERM 2000 CVH



The compact, fold-away stand and the two-stage power range (up to a maximum of 2,500 W) make the VOLCANO a universal all-rounder. It is easy to transport and is characterised by broad flexibility in its range of uses, both at home and in commercial settings.

The portable version of the TERM 2000 has been especially developed for easy and effective drying of paint and other materials. Weighing in at only 1.5 kg, it is easy to transport and can be used both horizontally and vertically.

APPLICATIONS

Home, hotels, offices, swimming pools, workshops



78 cm

TERM 2000 L&H FIX IP65

Available and combinable with:

PERFECTCLIME



1,75 kW

2,1 kW



IP65

LIGHT & HEAT

Wherever the „right“ brightness is important, our heating/light combination devices should be your first choice. In technology and design they are based on the tried TERM 2000-series in combination with 2- and 4-beam LED spots (240V/3,5W). The devices are waterproof according to IP65, heating and light are separately controllable and dimmable optionally – specially tuned dimmers are also available as accessories.

APPLICATIONS

Patios, balconies, summer houses, hobby rooms



1,75 kW
2,1 kW

82,5 cm



TERM 2000 L&H IP65 LED

Available and combinable with:

PERFECTCLIME



Mounting bracket included (L-Bracket)

IP65



4,2 kW

200 cm



TERM 2000 L&H

Available and combinable with:

PERFECTCLIME

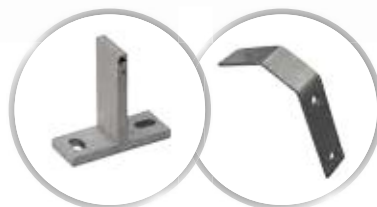

Mounting bracket included
Aluminum-Color-Heater: **T-Bracket**
Aluminum-Heater: **L-Bracket**

L&H



SMART IP24 **LOW GLARE**

Available and combinable with:

PERFECTCLIME

- 1,5 kW
- 2 kW
- 3 kW
- 4 kW
- 6 kW



(UL1278/UL2021)



24

SMART

The compact and uncomplicated SMART-series not only looks good in the garage, on your balcony or on your patio, but also proves a valuable aid in industry for the heating of individual workstations and for heating and drying materials. The large reflector provides optimum heat output at all times.

APPLICATIONS

Restaurants/cafes, hotels, patios, offices, dehumidification, garages, greenhouses, halls, household, churches, animal husbandry, workshops

40,5 cm

0,8 kW

1,5 kW

2 kW



SMART 2000 IP20



(UL1278/UL2021)



1,5 kW

2 kW



60,5 cm

SMART FRAME IP20



3 kW

Available as Outdoor IP24 from April/May 2017!

126 cm



SMART TOWER IP20



The first **Heating** & **Cooling** Sensation!

PATENTED

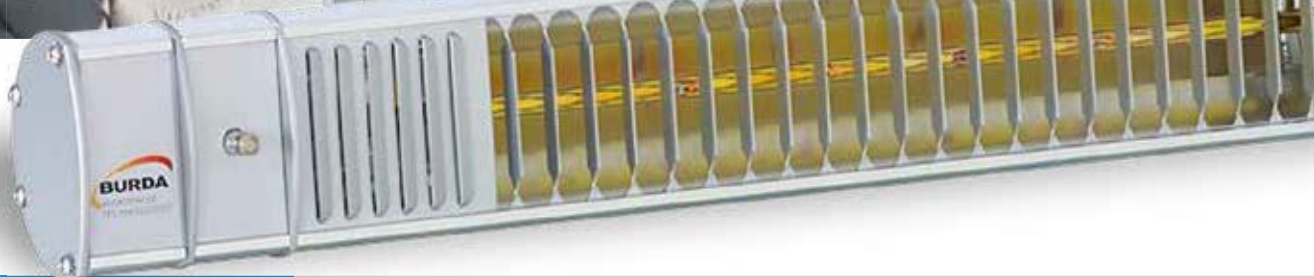

PERFECTCLIME®

The first heating & cooling concept combines infrared short-wave technology in one unit. Instant comfortable heat or refreshing cool air - resulting in a perfect temperature anytime and anywhere. Based on the successful TERM 2000 IP67 and SMART 2000 IP24, instant heating is guaranteed and due to the integrated nozzle a fine haze leads to a comfortable atmosphere for nearly unlimited professional and private usage. PERFECTCLIME® only at Burda!

APPLICATIONS

Patios, balconies, summer houses, hobby rooms



1,65 kW
2 kW



TERM 2000 IP67



Mounting bracket included
Color-Heater: **T-Bracket**
Aluminum-Heater: **L-Bracket**



1,75 kW
2,1 kW



87 cm

91 cm

TERM 2000 L&H



55,5 cm
63 cm
111,5 cm
151,5 cm

Available with one or two nozzles

1,5 kW
2 kW
3 kW
4 kW
6 kW



SMART 2000



(UL1278/UL2021)





CONTROL

Tailored to our infrared heating and lighting range, our accessories provide intelligent solutions for the use and operation of our systems. Dimmers, timers and remote control solutions enable optimized, customized heat management – simple and effective.

REMOTE DIMMERS



DIMMERS/TIMERS



MOTION DETECTORS/TEMPERATURE SENSORS





ADD ON

Are you looking for a way to install our systems temporarily and to quickly assemble and dismantle them? Our range of clamping and stand solutions are just what you're looking for – stability and rapid assembly guaranteed.

Standard with every Color and No Glare heater



T-BRACKET

Instead of a T-bracket you can mount the Color and No Glare heaters with our two other brackets **MB040** and the **Short bracket** (available as add-on)

Standard with every aluminum heater



L-BRACKET



AWNING BRACKET

Ideal for installations on awning profiles



SHORT BRACKET

It functions on Color and No Glare heaters in combination with our ceiling bracket **BCDF20** as a adapter for a stable mounting (available in white, black and anthracite)



CEILING BRACKET

Ceiling mounting **BCDF20** for Color, No Glare and aluminum heaters (available in white, black, anthracite and aluminum), 20 cm



PARASOL BRACKET

Strut clamp with star-shaped handle



POLE BRACKET

Strut and mast bracket with Velcro



TRIPOD STAND

Stand up to 210 cm

Promotion

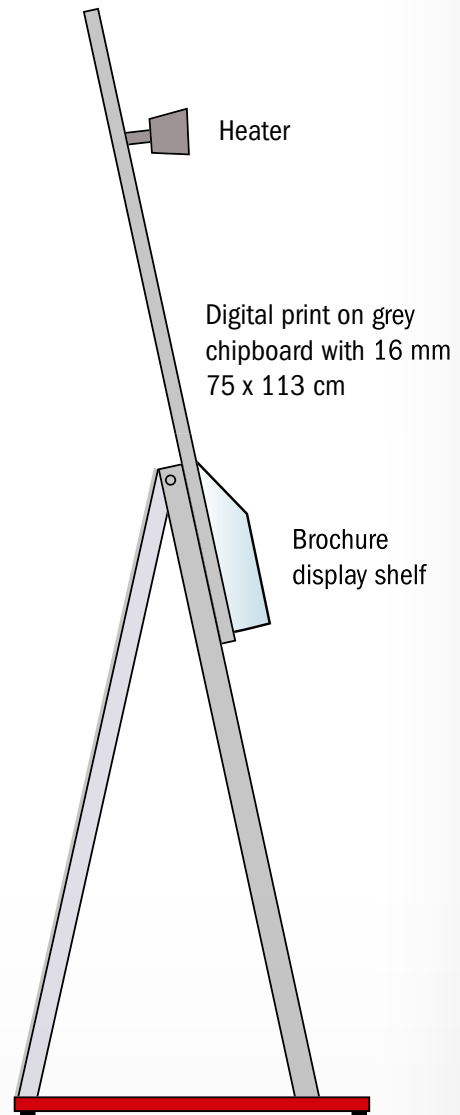

**YOU WILL BE INSPIRED BY
THE INNOVATIVE INFRARED
HEATER FROM BURDA.**

Convince your clients with intelligent comfortable heat at the push of a button. With this new professional display, guide the attention of your clients to our innovative heaters. The huge and instant heat output is most effective during this live demonstration.

A push-button timer and a display shelf for complimentary brochures is included.

PRODUCT OVERVIEW

WATTAGE · MATERIAL · CODE · EAN · IP PROTECTION CLASS · DIMENSIONS
WEIGHT · FEATURES · DESCRIPTION · CABLE LENGTH · POWER CONNECTION

WATTAGE	MATERIAL/ COLOR	CODE	EAN	IP PROTECTION CLASS	DIMENSIONS (W x H x D in cm)	WEIGHT (in g)	FEATURES	CABLE LENGTH	CONNECTION
---------	--------------------	------	-----	------------------------	---------------------------------	---------------	----------	--------------	------------



TERM 2000 BLUETOOTH APP & REMOTE

2 kW	White	BTURCAC200V9010	4260409692442	IP67	71 x 10 x 12,5	2500	2, 4	1,90m 3-wire 1,5mm ² , Schuko plug	1/N/PE ~ 230 V 50 Hz
2 kW	Anthracite	BTURCAC200V7016	4260409692459	IP67	71 x 10 x 12,5	2500	2, 4	1,90m 3-wire 1,5mm ² , Schuko plug	1/N/PE ~ 230 V 50 Hz
2 kW	Black	BTURCAC200V9005	4260409692435	IP67	71 x 10 x 12,5	2500	2, 4	1,90m 3-wire 1,5mm ² , Schuko plug	1/N/PE ~ 230 V 50 Hz



TERM 2000 IP67

1 x 1,0 kW	Polished aluminum	RCA100	4260051480503	IP67	45 x 9,5 x 12,5	2300	4	3m/1,90m 3-wire 1,5mm ² , Schuko plug	1/N/PE ~ 230 V 50 Hz
1 x 1,65 kW	Polished aluminum	RCA165	4260051480237	IP67	61 x 9,5 x 12,5	2500	4	1,90m 3-wire 1,5mm ² , Schuko plug	1/N/PE ~ 230 V 50 Hz
1 x 2,0 kW	Polished aluminum	RCA200V	4260051480275	IP67	61 x 9,5 x 12,5	2500	4	1,90m 3-wire 1,5mm ² , Schuko plug	1/N/PE ~ 230 V 50 Hz
1 x 1,0 kW	Polished aluminum	URCA100V	4260051485577	IP67	45 x 9,5 x 12,5	2300	2, 4	1,90m 3-wire 1,5mm ² , Schuko plug	1/N/PE ~ 230 V 50 Hz
1 x 1,5 kW	Polished aluminum	UPCRCA150V	4260051485553	IP67	65 x 9,5 x 12,5	2700	1, 2, 4	1,90m 3-wire 1,5mm ² , Schuko plug	1/N/PE ~ 230 V 50 Hz
1 x 1,5 kW	Polished aluminum	URCA150V	4260051485386	IP67	61 x 9,5 x 12,5	2700	2, 4	1,90m 3-wire 1,5mm ² , Schuko plug	1/N/PE ~ 230 V 50 Hz
1 x 1,5 kW	Polished aluminum	UPCRCA150V2	4260051485560	IP67	70 x 9,5 x 12,5	2900	1, 2, 4	1,90m 3-wire 1,5mm ² , Schuko plug	1/N/PE ~ 230 V 50 Hz
1 x 1,65 kW	Polished aluminum	URCA165V	4260051483863	IP67	61 x 9,5 x 12,5	2500	2, 4	1,90m 3-wire 1,5mm ² , Schuko plug	1/N/PE ~ 230 V 50 Hz
1 x 1,65 kW	Polished aluminum	UPCRCA165V2	4260051484426	IP67	70 x 9,5 x 12,5	2900	1, 2, 4	1,90m 3-wire 1,5mm ² , Schuko plug	1/N/PE ~ 230 V 50 Hz
1 x 2,0 kW	Polished aluminum	URCA200V	4260051484150	IP67	61 x 9,5 x 12,5	2500	2, 4	1,90m 3-wire 1,5mm ² , Schuko plug	1/N/PE ~ 230 V 50 Hz
1 x 2,0 kW	Polished aluminum	UPCRCA200V2	4260051484488	IP67	70 x 9,5 x 12,5	2900	1, 2, 4	1,90m 3-wire 1,5mm ² , Schuko plug	1/N/PE ~ 230 V 50 Hz



TERM 2000 COLOR IP67

1 x 1,50 kW	White	URCAC150V9010	4260051485607	IP67	61 x 9,5 x 12,5	2500	2, 4	1,90m 3-wire 1,5mm ² , Schuko plug	1/N/PE ~ 230 V 50 Hz
1 x 1,65 kW	White	URCAC165V9010	4260051485614	IP67	61 x 9,5 x 12,5	2500	2, 4	1,90m 3-wire 1,5mm ² , Schuko plug	1/N/PE ~ 230 V 50 Hz
1 x 2,0 kW	White	URCAC200V9010	4260051485621	IP67	61 x 9,5 x 12,5	2500	2, 4	1,90m 3-wire 1,5mm ² , Schuko plug	1/N/PE ~ 230 V 50 Hz
1 x 1,5 kW	Black	URCAC150V9005	4260051486222	IP67	61 x 9,5 x 12,5	2500	2, 4	1,90m 3-wire 1,5mm ² , Schuko plug	1/N/PE ~ 230 V 50 Hz
1 x 1,65 kW	Black	URCAC165V9005	4260051486239	IP67	61 x 9,5 x 12,5	2500	2, 4	1,90m 3-wire 1,5mm ² , Schuko plug	1/N/PE ~ 230 V 50 Hz
1 x 2,0 kW	Black	URCAC200V9005	4260051486246	IP67	61 x 9,5 x 12,5	2500	2, 4	1,90m 3-wire 1,5mm ² , Schuko plug	1/N/PE ~ 230 V 50 Hz
1 x 1,5 kW	Anthracite	URCAC150V7016	4260051488240	IP67	61 x 9,5 x 12,5	2700	2, 4	1,90m 3-wire 1,5mm ² , Schuko plug	1/N/PE ~ 230V 50Hz
1 x 1,65 kW	Anthracite	URCAC165V7016	4260051488257	IP67	61 x 9,5 x 12,5	2700	2, 4	1,90m 3-wire 1,5mm ² , Schuko plug	1/N/PE ~ 230V 50Hz
1 x 2,0 kW	Anthracite	URCAC200V7016	4260051486581	IP67	61 x 9,5 x 12,5	2700	2, 4	1,90m 3-wire 1,5mm ² , Schuko plug	1/N/PE ~ 230V 50Hz



TERM 2000 COLOR SHORT IP44

1 x 1,0 kW	White	URCACS01044V9010	4260051488592	IP44	46,4 x 9,5 x 12,5	2100	2	1,90m 3-wire 1,5mm ² , Schuko plug	1/N/PE ~ 230V 50Hz
1 x 1,50 kW	White	URCACS01544V9010	4260051488370	IP44	46,4 x 9,5 x 12,5	2100	2	1,90m 3-wire 1,5mm ² , Schuko plug	1/N/PE ~ 230V 50Hz
1 x 1,0 kW	Black	URCACS01044V9005	4260051488608	IP44	46,4 x 9,5 x 12,5	2100	2	1,90m 3-wire 1,5mm ² , Schuko plug	1/N/PE ~ 230V 50Hz
1 x 1,50 kW	Black	URCACS01544V9005	4260051488394	IP44	46,4 x 9,5 x 12,5	2100	2	1,90m 3-wire 1,5mm ² , Schuko plug	1/N/PE ~ 230V 50Hz
1 x 1,0 kW	Anthracite	URCACS01044V7016	4260051488615	IP44	46,4 x 9,5 x 12,5	2100	2	1,90m 3-wire 1,5mm ² , Schuko plug	1/N/PE ~ 230V 50Hz
1 x 1,50 kW	Anthracite	URCACS01544V7016	4260051488424	IP44	46,4 x 9,5 x 12,5	2100	2	1,90m 3-wire 1,5mm ² , Schuko plug	1/N/PE ~ 230V 50Hz

WATTAGE	MATERIAL/ COLOR	CODE	EAN	IP PROTECTION CLASS	DIMENSIONS (W x H x D in cm)	WEIGHT (in g)	FEATURES	CABLE LENGTH	CONNECTION
---------	--------------------	------	-----	------------------------	---------------------------------	---------------	----------	--------------	------------



TERM 2000 MULTI

2 x 1,65 kW	Polished aluminum	RCJ330	4260051480435	IP67	132,5 x 9,5 x 12,5	4900	4	0,65 m 5-wire 1,5mm ² , Wire-end sleeves	2/N/PE ~ 400 (2N) V 50Hz
2 x 2,0 kW	Polished aluminum	RCJ400V	4260051480442	IP67	132,5 x 9,5 x 12,5	4900	4	0,65 m 5-wire 1,5mm ² , Wire-end sleeves	2/N/PE ~ 400 (2N) V 50Hz
2 x 1,65 kW	Polished aluminum	URCJ330V	4260051483870	IP67	132 x 9,5 x 12,5	4900	2, 4	0,65 m 5-wire 1,5mm ² , Wire-end sleeves	2/N/PE ~ 400 (2N) V 50Hz
2 x 2,0 kW	Polished aluminum	URCJ400V	4260051483887	IP67	132 x 9,5 x 12,5	4900	2, 4	0,65 m 5-wire 1,5mm ² , Wire-end sleeves	2/N/PE ~ 400 (2N) V 50Hz
3 x 1,65 kW	Polished aluminum	URCC495V	4260051483894	IP67	60 x 29 x 12,5	6800	2, 4	0,65 m 5-wire 2,5mm ² , Wire-end sleeves	2/N/PE ~ 400 (2N) V 50Hz
3 x 2,0 kW	Polished aluminum	URCC600V	4260051483900	IP67	60 x 29 x 12,5	6800	2, 4	0,65 m 5-wire 2,5mm ² , Wire-end sleeves	2/N/PE ~ 400 (2N) V 50Hz



TERM 2000 IP24 ULTRA LOW GLARE

1 x 2,0 kW	Alu poliert	RCA02024	4260051480725	IP24	51 x 9,5 x 12,5	2300		1,90 m 3-wire 1,5mm ² , Schuko plug	1/N/PE ~ 230 V 50 Hz
------------	-------------	----------	---------------	------	-----------------	------	--	---	-------------------------



TERM 2000 IP44 ULTRA LOW GLARE

1 x 1,0 kW	Polished aluminum	URCA01044V	4260051488653	IP44	51,5 x 9,5 x 12,5	2300	2	1,90 m 3-wire 1,5mm ² , Schuko plug	1/N/PE ~ 230V 50Hz
1 x 1,5 kW	Polished aluminum	URCA01544V	4260051488509	IP44	51,5 x 9,5 x 12,5	2300	2	1,90 m 3-wire 1,5mm ² , Schuko plug	1/N/PE ~ 230V 50Hz



TERM 2000 IP20 NO GLARE

1 x 1,0 kW	Polished aluminum	NRCA100	4260051488574	IP20	41 x 9,5 x 12,5	2100	3	1,90 m 3-wire 1,5mm ² , Schuko plug	1/N/PE ~ 230 V 50 Hz
1 x 0,65 kW	White	NRCA065	4260051488523	IP20	35,7 x 12,5 x 8	2100	3	1,90 m 3-wire 1,5mm ² , Schuko plug	1/N/PE ~ 230V 50Hz
1 x 0,65 kW	Black	NRCA065-1	4260051488530	IP20	35,7 x 12,5 x 8	2100	3	1,90 m 3-wire 1,5mm ² , Schuko plug	1/N/PE ~ 230V 50Hz
2 x 0,65 kW	White	NRCJ130	4260051488554	IP20	60,7 x 12,5 x 8	3000	3	1,90 m 3-wire 1,5mm ² , Schuko plug	1/N/PE ~ 230V 50Hz
2 x 0,65 kW	Black	NRCJ130-1	4260051488547	IP20	60,7 x 12,5 x 8	3000	3	1,90 m 3-wire 1,5mm ² , Schuko plug	1/N/PE ~ 230V 50Hz
3 x 0,65 kW	White	NRCK195	4260051488677	IP20	85,5 x 12,5 x 8	3800	3	1,90 m 3-wire 1,5mm ² , Schuko plug	1/N/PE ~ 230V 50Hz
3 x 0,65 kW	Black	NRCK195-1	4260051488684	IP20	85,5 x 12,5 x 8	3800	3	1,90 m 3-wire 1,5mm ² , Schuko plug	1/N/PE ~ 230V 50Hz



TERM 2000 IP65 L&H LED

1,65 + 2 x 3,5W	Polished aluminum	URLH1765	4260051484020	IP65	82,5 x 9,5 x 12,5	3350	2, 4, 5	2 m 5-wire 1,5mm ² , Wire-end sleeves	2/N/PE ~ 230 V 50 Hz
1,65 + 2 x 3,5W	Polished aluminum	UPCRLH1765	4260051484556	IP65	91 x 9,5 x 12,5	4050	1, 2, 4, 5	2 m 5-wire 1,5mm ² , Wire-end sleeves	2/N/PE ~ 230 V 50 Hz
2,0 + 2 x 3,5W	Polished aluminum	URLH2165	4260051484037	IP65	82,5 x 9,5 x 12,5	3350	2, 4, 5	2 m 5-wire 1,5mm ² , Wire-end sleeves	2/N/PE ~ 230 V 50 Hz
2,0 + 2 x 3,5W	Polished aluminum	UPCRLH2165	4260051484570	IP65	91 x 9,5 x 12,5	4050	1, 2, 4, 5	2 m 5-wire 1,5mm ² , Wire-end sleeves	2/N/PE ~ 230 V 50 Hz
1,65 + 2 x 3,5W	Polished aluminum	URLH1765F	4260051484044	IP65	78 x 9,5 x 12,5	3350	2, 4, 5	2 m 5-wire 1,5mm ² , Wire-end sleeves	2/N/PE ~ 230 V 50 Hz
1,65 + 2 x 3,5W	Polished aluminum	UPCRLH1765F	4260051484563	IP65	87 x 9,5 x 12,5	4050	1, 2, 4, 5	2 m 5-wire 1,5mm ² , Wire-end sleeves	2/N/PE ~ 230 V 50 Hz
2,0 + 2 x 3,5W	Polished aluminum	URLH2165F	4260051484051	IP65	78 x 9,5 x 12,5	3350	2, 4, 5	2 m 5-wire 1,5mm ² , Wire-end sleeves	2/N/PE ~ 230 V 50 Hz
2,0 + 2 x 3,5W	Polished aluminum	UPCRLH2165F	4260051484594	IP65	87 x 9,5 x 12,5	4050	1, 2, 4, 5	2 m 5-wire 1,5mm ² , Wire-end sleeves	2/N/PE ~ 230 V 50 Hz

FEATURES: 1 = PERFECTCLIME

2 = ULTRA LOW GLARE
(100% heat with 80% less light!)



3 = NO GLARE
(100% light reduction!)



4 = Waterproof



5 = Light



6 = LOW GLARE



WATTAGE	MATERIAL/ COLOR	CODE	EAN	IP PROTECTION CLASS	DIMENSIONS (W x H x D in cm)	WEIGHT (in g)	FEATURES	CABLE LENGTH	CONNECTION
---------	--------------------	------	-----	------------------------	---------------------------------	---------------	----------	--------------	------------



TERM 2000 IP65 L&H LED

2 x 2,0 + 4 x 3,5 W	Polished aluminum	URLH4265	4260051484075	IP65	200 x 9,5 x 12,5	7100	2, 4, 5	2m 5-wire 2,5 mm ² , Wire-end sleeves	3/N/PE ~ 235 V 50 Hz
2 x 2,0 + 4 x 3,5 W	Polished aluminum	UPCRLH4265	4260051484624	IP65	200 x 9,5 x 12,5	7700	1, 2, 4, 5	2m 5-wire 2,5 mm ² , Wire-end sleeves	3/N/PE ~ 235 V 50 Hz
2 x 2,0 + 4 x 3,5 W	Anthracite	URLHC42657016	4260409692602	IP65	200 x 9,5 x 12,5	7100	2, 4, 5	2m 5-wire 2,5 mm ² , Wire-end sleeves	3/N/PE ~ 235 V 50 Hz
2 x 2,0 + 4 x 3,5 W	White	URLHC42659010	4260409691575	IP65	200 x 9,5 x 12,5	7100	2, 4, 5	2m 5-wire 2,5 mm ² , Wire-end sleeves	3/N/PE ~ 235 V 50 Hz
2 x 2,0 + 4 x 3,5 W	Black	URLHC42659005	4260409691582	IP65	200 x 9,5 x 12,5	7100	2, 4, 5	2m 5-wire 2,5 mm ² , Wire-end sleeves	3/N/PE ~ 235 V 50 Hz



TERM TOWER PALMS

2 x 2,0 kW	Polished aluminum	URTT400V	4260051483917	IP67	110 x 250-270	ca. 45000	2, 4	10m 5-wire 2,5 mm ² , Wire-end sleeves	3/N/PE ~ 400 (3N) V 50 Hz
2 x 2,0 kW	Polished aluminum	UPCRTT400V	4260051484631	IP67	110 x 250-270	ca. 45000	1, 2, 4	10m 5-wire 2,5 mm ² , Wire-end sleeves	3/N/PE ~ 400 (3N) V 50 Hz
3 x 2,0 kW	Polished aluminum	URTT600V	4260051483924	IP67	110 x 250-270	ca. 45000	2, 4	10m 5-wire 2,5 mm ² , Wire-end sleeves	3/N/PE ~ 400 (3N) V 50 Hz
3 x 2,0 kW	Polished aluminum	UPCRTT600V	4260051484648	IP67	110 x 250-270	ca. 45000	1, 2, 4	10m 5-wire 2,5 mm ² , Wire-end sleeves	3/N/PE ~ 400 (3N) V 50 Hz
4 x 2,0 kW	Polished aluminum	URTT800V	4260051483931	IP67	110 x 250-270	ca. 45000	2, 4	10m 5-wire 2,5 mm ² , Wire-end sleeves	3/N/PE ~ 400 (3N) V 50 Hz
4 x 2,0 kW	Polished aluminum	UPCRTT800V	4260051484365	IP67	110 x 250-270	ca. 45000	1, 2, 4	10m 5-wire 2,5 mm ² , Wire-end sleeves	3/N/PE ~ 400 (3N) V 50 Hz
2 x 1,50 kW	Black	URTT300V9005	4260051488578	IP67	110 x 250-270	ca. 45000	2, 4	10m 5-wire 2,5 mm ² , Wire-end sleeves	3/N/PE-400 (3N) V 50 Hz
2 x 2,0 kW	Black	URTT400V9005	4260051487779	IP67	110 x 250-270	ca. 45000	2, 4	10m 5-wire 2,5 mm ² , Wire-end sleeves	3/N/PE-400 (3N) V 50 Hz
3 x 2,0 kW	Black	URTT600V9005	4260051487786	IP67	110 x 250-270	ca. 45000	2, 4	10m 5-wire 2,5 mm ² , Wire-end sleeves	3/N/PE-400 (3N) V 50 Hz
4 x 2,0 kW	Black	URTT800V9005	4260051487793	IP67	110 x 250-270	ca. 45000	2, 4	10m 5-wire 2,5 mm ² , Wire-end sleeves	3/N/PE-400 (3N) V 50 Hz
2 x 1,50 kW	White	URTT300V9010	4260051488585	IP67	110 x 250-270	ca. 45000	2, 4	10m 5-wire 2,5 mm ² , Wire-end sleeves	3/N/PE-400 (3N) V 50 Hz
2 x 2,0 kW	White	URTT400V9010	4260051488196	IP67	110 x 250-270	ca. 45000	2, 4	10m 5-wire 2,5 mm ² , Wire-end sleeves	3/N/PE-400 (3N) V 50 Hz
3 x 2,0 kW	White	URTT600V9010	4260051488202	IP67	110 x 250-270	ca. 45000	2, 4	10m 5-wire 2,5 mm ² , Wire-end sleeves	3/N/PE-400 (3N) V 50 Hz
4 x 2,0 kW	White	URTT800V9010	4260051488219	IP67	110 x 250-270	ca. 45000	2, 4	10m 5-wire 2,5 mm ² , Wire-end sleeves	3/N/PE-400 (3N) V 50 Hz



TERM TOWER TABLE

TERM TOWER TABLE	RTTT	4260051480589
TERM TOWER ASHTRAY	RTTA	4260051480596



TERM 2000 CVH IP20

1 x 2,0 kW	Black	RCAC020VH-1	4260051482293	IP20	42,5 x 15 x 21	1500		1,90m 3-wire 1,5 mm ² , Schuko plug	1/N/PE ~ 230 V 50 Hz
1 x 2,0 kW	Red	RCAC020VH-4	4260051482309	IP20	42,5 x 15 x 21	1500		1,90m 3-wire 1,5 mm ² , Schuko plug	1/N/PE ~ 230 V 50 Hz



TERM 2500 VOLCANO IP20

1 + 1,5 kW	Schwarz	RC V 025	4260051482507	IP20	41 x 52 x 31	5450		1,90m 3-wire 1,5 mm ² , Schuko plug	1/N/PE ~ 230 V 50 Hz
------------	---------	----------	---------------	------	--------------	------	--	---	-------------------------





BLUETOOTH SMART IP24

1 x 2,0 kW	White	BTBHS2024	4260409693135	IP24	48 x 14,5 x 9,5	2500	6	1,90m 3-wire 1,5mm ² , Schuko plug	1/N/PE ~ 230 V 50 Hz
1 x 2,0 kW	Black	BTBHS2024-1	4260409693142	IP24	48 x 14,5 x 9,5	2500	6	1,90m 3-wire 1,5mm ² , Schuko plug	1/N/PE ~ 230 V 50 Hz
1 x 2,0 kW	Silver	BTBHS2024-3	4260409693159	IP24	48 x 14,5 x 9,5	2500	6	1,90m 3-wire 1,5mm ² , Schuko plug	1/N/PE ~ 230 V 50 Hz



BLUETOOTH SMART IP24 MULTI

2 x 1,5kW	White	BTBHS3024	4260409694002	IP24	89,5 x 14,5 x 9,5	4000	6	1,90m 5-wire 2,5mm ² , Wire-end sleeves	3/N/PE ~ 400 (3N) V 50 Hz
2 x 1,5kW	Silver	BTBHS3024-3	4260409694019	IP24	89,5 x 14,5 x 9,5	4000	6	1,90m 5-wire 2,5mm ² , Wire-end sleeves	3/N/PE ~ 400 (3N) V 50 Hz
2 x 1,5kW	Black	BTBHS3024-1	4260409694026	IP24	89,5 x 14,5 x 9,5	4000	6	1,90m 5-wire 2,5mm ² , Wire-end sleeves	3/N/PE ~ 400 (3N) V 50 Hz



BLUETOOTH SMART TOWER IP24

2 x 1,5 kW	Black	BTBHST3024-1	4260409693722	IP24	29 x 126 x 32	7300	6	1,90m 3-wire 1,5mm ² , Schuko plug	1/N/PE ~ 230 V 50 Hz
2 x 1,5 kW	White	BTBHST3024-2	4260409693739	IP24	29 x 126 x 32	7300	6	1,90m 3-wire 1,5mm ² , Schuko plug	1/N/PE ~ 230 V 50 Hz
2 x 1,5 kW	Silver	BTBHST3024-3	4260409693746	IP24	29 x 126 x 32	7300	6	1,90m 3-wire 1,5mm ² , Schuko plug	1/N/PE ~ 230 V 50 Hz



SMART IP24

1 x 1,5 kW	White	BHS1524	4260051489568	IP24	48 x 14,5 x 9,5	2500	6	1,90m 3-wire 1,5mm ² , Schuko plug	1/N/PE ~ 230 V 50 Hz
1 x 1,5 kW	White	PCBHS1524	4260051485034	IP24	55,5 x 14,5 x 9,5	2500	1,6	1,90m 3-wire 1,5mm ² , Schuko plug	1/N/PE ~ 230 V 50 Hz
1 x 1,5 kW	White	PCBHS15242	4260051486536	IP24	63 x 14,5 x 9,5	2500	1,6	1,90m 3-wire 1,5mm ² , Schuko plug	1/N/PE ~ 230 V 50 Hz
1 x 1,5 kW	Silver	BHS1524-3	4260051489551	IP24	48 x 14,5 x 9,5	2500	6	1,90m 3-wire 1,5mm ² , Schuko plug	1/N/PE ~ 230 V 50 Hz
1 x 2,0 kW	White	BHS2024	4260051489575	IP24	48 x 14,5 x 9,5	2500	6	1,90m 3-wire 1,5mm ² , Schuko plug	1/N/PE ~ 230 V 50 Hz
1 x 2,0 kW	White	PCBHS2024	4260051485041	IP24	55,5 x 14,5 x 9,5	2500	1,6	1,90m 3-wire 1,5mm ² , Schuko plug	1/N/PE ~ 230 V 50 Hz
1 x 2,0 kW	White	PCBHS20242	4260051486543	IP24	63 x 14,5 x 9,5	2500	1,6	1,90m 3-wire 1,5mm ² , Schuko plug	1/N/PE ~ 230 V 50 Hz
1 x 2,0 kW	Silver	BHS2024-3	4260051489582	IP24	48 x 14,5 x 9,5	2500	6	1,90m 3-wire 1,5mm ² , Schuko plug	1/N/PE ~ 230 V 50 Hz
1 x 2,0 kW	Black	BHS2024-1	4260051480053	IP24	48 x 14,5 x 9,5	2500	6	1,90m 3-wire 1,5mm ² , Schuko plug	1/N/PE ~ 230 V 50 Hz



SMART IP24 MULTI

2 x 1,5 kW	White	BHS3024	4260051487243	IP24	89,5 x 14,5 x 9,5	4000	6	1,90m 5-wire 2,5mm ² , Wire-end sleeves	3/N/PE ~ 400 (3N) V 50 Hz
2 x 1,5 kW	White	PCBHS30242	4260051485065	IP24	111,5 x 14,5 x 9,5	4000	1,6	1,90m 5-wire 2,5mm ² , Wire-end sleeves	3/N/PE ~ 400 (3N) V 50 Hz
2 x 2,0 kW	White	BHS4024	4260051487267	IP24	89,5 x 14,5 x 9,5	4000	6	0,65m 5-wire 2,5mm ² , Wire-end sleeves	3/N/PE ~ 400 (3N) V 50 Hz
2 x 2,0 kW	White	PCBHS40242	4260051485089	IP24	111,5 x 14,5 x 9,5	4000	1,6	0,65m 5-wire 2,5mm ² , Wire-end sleeves	3/N/PE ~ 400 (3N) V 50 Hz
3 x 2,0 kW	White	BHS6024	4260051487281	IP24	129 x 14,5 x 9,5	6000	6	0,65m 5-wire 2,5mm ² , Wire-end sleeves	3/N/PE ~ 400 (3N) V 50 Hz
3 x 2,0 kW	White	PCBHS60242	4260051485102	IP24	151,5 x 14,5 x 9,5	6000	1,6	0,65m 5-wire 2,5mm ² , Wire-end sleeves	3/N/PE ~ 400 (3N) V 50 Hz





SMART TOWER DIMMER IP20

2 x 1,5 kW	Black	BHST30-1	4260051487175	IP20	29 x 126 x 32	7300	6	1,90 m 3-wire 1,5 mm ² , Schuko plug	1/N/PE ~ 230 V 50 Hz
2 x 1,5 kW	White	BHST30-2	4260051487182	IP20	29 x 126 x 32	7300	6	1,90 m 3-wire 1,5 mm ² , Schuko plug	1/N/PE ~ 230 V 50 Hz
2 x 1,5 kW	Silver	BHST30-3	4260051487199	IP20	29 x 126 x 32	7300	6	1,90 m 3-wire 1,5 mm ² , Schuko plug	1/N/PE ~ 230 V 50 Hz
2 x 1,5 kW	Red	BHST30-4	4260051487205	IP20	29 x 126 x 32	7300	6	1,90 m 3-wire 1,5 mm ² , Schuko plug	1/N/PE ~ 230 V 50 Hz



SMART IP20

1 x 0,8 kW	White	BHS08	4260051487137	IP20	31 x 14,5 x 9,5	1900	6	1,90 m 3-wire 1,5 mm ² , Schuko plug	1/N/PE ~ 230 V 50 Hz
1 x 1,3 kW	White	BHS13	4260051487113	IP20	31 x 14,5 x 9,5	1900	6	1,90 m 3-wire 1,5 mm ² , Schuko plug	1/N/PE ~ 230 V 50 Hz
1 x 1,5 kW	White	BHS15	4260051487014	IP20	40,5 x 14,5 x 9,5	2200	6	1,90 m 3-wire 1,5 mm ² , Schuko plug	1/N/PE ~ 230 V 50 Hz
1 x 1,5 kW	Silver	BHS15-3	4260051487045	IP20	40,5 x 14,5 x 9,5	2200	6	1,90 m 3-wire 1,5 mm ² , Schuko plug	1/N/PE ~ 230 V 50 Hz
1 x 2,0 kW	White	BHS20	4260051487021	IP20	40,5 x 14,5 x 9,5	2200	6	1,90 m 3-wire 1,5 mm ² , Schuko plug	1/N/PE ~ 230 V 50 Hz
1 x 2,0 kW	Silver	BHS20-3	4260051487052	IP20	40,5 x 14,5 x 9,5	2200	6	1,90 m 3-wire 1,5 mm ² , Schuko plug	1/N/PE ~ 230 V 50 Hz
1 x 2,0 kW	Black	BHS20-1	4260051487236	IP20	40,5 x 14,5 x 9,5	2200	6	1,90 m 3-wire 1,5 mm ² , Schuko plug	1/N/PE ~ 230 V 50 Hz



SMART FRAME IP20

1 x 1,5 kW	White	BHSF15-2	4260051487304	IP20	60 x 32,5 x 10	4900	6	1,90 m 3-wire 1,5 mm ² , Schuko plug	1/N/PE ~ 230 V 50 Hz
1 x 1,5 kW	Silver	BHSF15-3	4260051487311	IP20	60 x 32,5 x 10	4900	6	1,90 m 3-wire 1,5 mm ² , Schuko plug	1/N/PE ~ 230 V 50 Hz
1 x 2,0 kW	White	BHSF20-2	4260051487328	IP20	60 x 32,5 x 10	4900	6	1,90 m 3-wire 1,5 mm ² , Schuko plug	1/N/PE ~ 230 V 50 Hz
2,0 kW	Silver	BHSF20-3	4260051487335	IP20	60 x 32,5 x 10	4900	6	1,90 m 3-wire 1,5 mm ² , Schuko plug	1/N/PE ~ 230 V 50 Hz



BLUETOOTH DIMMER

3 kW, 1 Zone	Aluminum	BTD3	4260409691094	IP65	11,8 x 8,8 x 4,8	900	4	1,90 m 3-wire 1,5 mm ² , Schuko plug	1/N/PE ~ 230 V 50 Hz
-----------------	----------	------	---------------	------	------------------	-----	---	---	----------------------



REMOTE SOFTSTART DIMMER

0,25 kw	Dimmer 50/66/100%	BRFE025	4260051489285	IP54	4,8 x 2,0 x 2,0	500		Power cable 490 mm (STAS 3), cable to heater 235 mm (STAK 3)	1/N/PE ~ 230 V 50 Hz
2,0 kw	Dimmer 50/66/100%	BRFE20	4260051489261	IP54	4,8 x 2,0 x 2,0	500		Power cable 490 mm (STAS 3), cable to heater 235 mm (STAK 3)	1/N/PE ~ 230 V 50 Hz
4,0 kw	Dimmer 50/66/100%	BRFE40	4260051489278	IP56	16,7 x 15,3 x 11,8	1.000		Fixed connection	1/N/PE ~ 230 V 50 Hz





REMOTE CONTROL TRANSMITTER

BIDirectional Solo 1 Channel	Black	BRD_S1	4260051489209	IP20	7,4 x 4,4 x 1,5	120
BIDirectional Solo 1 Channel	White	BRD_S2	4260051489216	IP20	7,4 x 4,4 x 1,5	120
BIDirectional Solo 1 Channel	Silver	BRD_S3	4260051489223	IP20	7,4 x 4,4 x 1,5	120
BIDirectional Mono 1 Channel	Silver	BRD-BM3	4260051483801	IP20	5,1 x 12 x 2,6	120
BIDirectional Mono 1 Channel	White	BRD-BM2	4260051483818	IP20	5,1 x 12 x 2,6	120
BIDirectional Mono 1 Channel	Anthracite	BRD-BM5	4260051484204	IP20	5,1 x 12 x 2,6	120
BIDirectional Varlo 5 Channel	White	BRD-BV2	4260051483825	IP20	5,1 x 12 x 2,6	120
BIDirectional Varlo 5 Channel	Silver	BRD-BV3	4260051483832	IP20	5,1 x 12 x 2,6	120
BIDirectional Varlo 5 Channel	Anthracite	BRD-BV5	4260051484211	IP20	5,1 x 12 x 2,6	120



TIMER SOFTSTART

1 x 2,0 kW	White	TS2-C	4260051480107	IP20	9,5 x 13 x 5,5	475	1,5m 3-wire 1,5mm ² PVC; 0,5m 3-wire 1,5mm ² PVC, Schuko plug	1/N/PE ~ 230 V 50 Hz
1 x 4,0 kW	White	TS4	4260051480077	IP65	10 x 12,5 x 7	475	1,5m 3-wire 1,5mm ² PVC; 0,5m 3-wire 1,5mm ² PVC, Schuko plug	1/N/PE ~ 230 V 50 Hz
1 x 6,0 kW	White	TS6	4260409691254	IP65	13 x 13 x 7	475	1,5m 3-wire 1,5mm ² PVC; 0,5m 3-wire 1,5mm ² PVC, Schuko plug	1/N/PE ~ 230 V 50 Hz



BH CONTROLLER 1 ZONE IP65

4,0 kw, 1 Zone	White	BHC4001	4260051480169	IP65	28 x 17 x 8,7	2150	2,5mm ² , Fixed connection	1/N/PE ~ 230 V 50 Hz
6,0 kw, 1 Zone	White	BHC6001	4260051481562	IP65	28 x 17 x 8,7	2150	2,5mm ² , Schuko plug	1/N/PE ~ 230 V 50 Hz
Remote control 1	White	BHCR1	4260051480176	IP20	4,5 x 26 x 2	80		
BPIR	White	BPIR	4260051485942	IP65	10 x 8 x 11,7	140		



BH CONTROLLER 9 ZONE IP65

4,0 kw, 2 Zones	White	BHC4002-ER	4260051482835	IP65	28 x 17 x 8,7	2150	2,5mm ² , Fixed connection	1/N/PE ~ 230 V 50 Hz
6,0 kw, 3 Zones	White	BHC6003-ER	4260051482842	IP65	28 x 17 x 8,7	2150	2,5mm ² , Fixed connection	3/N/PE ~ 400 V 50 Hz
4,0 kw, 2 Zones	White	BHC4002D	4260051483443	IP65	28 x 17 x 8,7	2150	2,5mm ² , Fixed connection	1/N/PE ~ 230 V 50 Hz
6,0 kw, 3 Zones	White	BHC6003D	4260051483450	IP65	28 x 17 x 8,7	2150	2,5mm ² , Fixed connection	3/N/PE ~ 400 V 50 Hz
Remote control 9	White	BHCR9	4260051483306	IP20	4,5 x 26 x 2	80		
Keypad	White	BHCK	4260051483559	IP65	12 x 9 x 4	220		



MOTION DETECTOR WITH TEMPERATURE SENSOR

BPIR4, 4,0 kw	White	BPIR4	4260051485959	IP65	10 x 10 x 6	280	2,5mm ² , Fixed connection	1/N/PE ~ 230 V 50 Hz
BPIR6, 6,0 kw	White	BPIR6	4260051485966	IP65	13 x 13 x 7,5	600	2,5mm ² , Fixed connection	1/N/PE ~ 230 V 50 Hz



FIXATIONS

DESCRIPTION	CODE	EAN	DIMENSIONS (Length in cm)	WEIGHT (in g)
Ceiling fixture Polished aluminum	BCDF20	4260409691452	20	50
Ceiling fixture white	BCDF209010	4260409691469	20	50
Ceiling fixture black	BCDF209005	4260409691476	20	50
Ceiling fixture anthracite	BCDF207016	4260409691483	20	50
Modular fixture anthracite	MB40402007016	4260409693418	20	55
Modular fixture black	MB40402009005	4260409693425	20	55
Modular fixture white	MB40402009010	4260409693432	20	55
Modular fixture white	MB40409010	4260409692176	40	50
Modular fixture black	MB40409005	4260409692534	40	50
Modular fixture anthracite	MB40407016	4260409692619	40	50
L-Bracket polished aluminium	BCLF	4260409693494	13	50
Short Bracket polished aluminum	BCSF	4260409693715	2,5	50
Short Bracket white	BCSF9010	4260409693463	2,5	50
Short bracket black	BCSF9005	4260409693470	2,5	50
Short Bracket anthracite	BCSF7016	4260409693487	2,5	50
T-Bracket white	BCTF9010	4260409692961	8	50
T-Bracket black	BCTF9005	4260409692978	8	50
T-Bracket anthracite	BCTF7016	4260409692985	8	50



CLAMPS

DESCRIPTION	CODE	EAN
Strut clamp, 1 heater white	KLS1W	4260051489131
Strut clamp, 1 heater silver	KLS1S	4260051489148
Strut bracket with velcro, 1 heater white	KLS1KW	4260051489155

STANDS



DESCRIPTION	CODE	EAN
BH_SMART STAND, White	BHSS-2	4260051487144
BH_SMART STAND, Silver	BHSS-3	4260051487151
BH_SMART STAND, Black	BHSS-1	4260051481357



HIRSCHMANN SET



DESCRIPTION	CODE	EAN
BRHS	STAS 3 + STAK 3 + Stasi	4260051489094



PERFECTCLIME PUMP

DESCRIPTION	CODE	EAN	PRESSURE	CONSUMPTION
Pump 05	PCE05	4260051482347	60 Bar	0,5 l/m
Pump 1	PCE1	4260051482354	60 Bar	0,9 l/m
Pump 3	PCE3	4260051482361	60 Bar	3,0 l/m

PERFECTCLIME COUPLINGS (6,35 mm)

DESCRIPTION	CODE	EAN	PICTURE
T-Coupling	PCKT	4260051483245	
L-Coupling	PCKL	4260051483252	
Straight Coupling	PCKS	4260051483856	
End-Coupling	PCKE	4260051483269	
Angle Coupling	PCKG	4260051483276	

PERFECTCLIME POLYAMID PIPELINE (6,35 mm)

DESCRIPTION	CODE	EAN	PICTURE
Polyamid Pipeline 25 cm	PCPS25	4260051483290	
Polyamid Pipeline 75 cm Gerte	PCPG7	4260051483313	
Polyamid Cutter	PCPC	4260051483320	
Polyamid pipe mounting	PCPB	4260051483337	



PERFECTCLIME NOZZLES

DESCRIPTION	CODE	EAN	56 BAR VERSION	70 BAR VERSION	84 BAR VERSION
Nozzle 0,15 mm	PCN15	4260051483207	0,041 l/min 0.011 US Gpm	0,046 l/min 0.0095 US Gpm	0,051 l/min 0.012 US Gpm
Nozzle 0,20 mm	PCN20	4260051483214	0,080 l/min 0.021 US Gpm	0,089 l/min 0.024 US Gpm	0,098 l/min 0.026 US Gpm
Nozzle 0,30 mm	PCN30	4260051483221	0,130 l/min 0.034 US Gpm	0,145 l/min 0.038 US Gpm	0,159 l/min 0.042 US Gpm
Nozzle 0,40 mm	PCN40	4260051483238	0,159 l/min 0.047 US Gpm	0,178 l/min 0.047 US Gpm	0,195 l/min 0.052 US Gpm



PERFECTCLIME FILTER

DESCRIPTION	CODE	EAN
Filter clause chalk	PCFKUEU	4260051483344
Particle filter	PCFS	4260051483351



PERFECTCLIME UV-FILTER

CODE	EAN	CAPACITY	PRESSURE
PCFUV4	4260051482880	480 l/h	6 Bar
PCFUV5	4260051482897	500 l/h	7-10 Bar
PCFUV10	4260051482972	1000 l/h	7-10 Bar
PCFUV30	4260051482989	3000 l/h	7-10 Bar

RÖHREN TERM 2000 IP20/IP24/IP44

BEZEICHNUNG	LEISTUNG	CODE	EAN	IP ANGABE	ABMESSUNGEN (Länge in cm)	GEWICHT (in g)	KABELLÄNGE	STROM- ANSCHLUSS
IP20 Cable 357,5 mm	1,0 kW	LG1000	4260051486017	IP20	35,75	50	295 mm double-sided, Wire-end sleeves	1/N/PE ~ 230V/50Hz
IP20 Cable 357,5 mm	1,0 kW	LG1000V	4260051486048	IP20	35,75	50	295 mm double-sided, Wire-end sleeves	1/N/PE ~ 230V/50Hz
IP20 Cable 357,5 mm	1,5 kW	LG1500	4260051486024	IP20	35,75	50	295 mm double-sided, Wire-end sleeves	1/N/PE ~ 230V/50Hz
IP20 Cable 357,5 mm	1,5 kW	LG1500V	4260051486000	IP20	35,75	50	295 mm double-sided, Wire-end sleeves	1/N/PE ~ 230V/50Hz
IP20 Cable 357,5 mm	2,0 kW	LG2000	4260051486031	IP20	35,75	50	295 mm double-sided, Wire-end sleeves	1/N/PE ~ 230V/50Hz
IP24 Cable 355 mm	1,0 kW	LG1024	4260051486123	IP24	35,5	50	235 mm and 590 mm, Wire-end sleeves	1/N/PE ~ 230V/50Hz
IP24 Cable 355 mm	1,5 kW	LG1524	4260051486130	IP24	35,5	50	295 mm double-sided, Wire-end sleeves	1/N/PE ~ 230V/50Hz
IP24 Cable 355 mm	2,0 kW	LG2024	4260051486147	IP24	35,5	50	235 mm and 590 mm, Wire-end sleeves	1/N/PE ~ 230V/50Hz
IP24 Cable 355 mm	1,0 kW	ULGS1024V	4260051485454	IP24	35,5	50	235 mm and 590 mm, Wire-end sleeves	1/N/PE ~ 230V/50Hz
IP24 Cable 355 mm	1,5 kW	ULGS1524V	4260051484129	IP24	35,5	50	235 mm and 590 mm, Wire-end sleeves	1/N/PE ~ 230V/50Hz
IP24 Cable 355 mm	2,0 kW	ULGS2024V	4260051484136	IP24	35,5	50	235 mm and 590 mm, Wire-end sleeves	1/N/PE ~ 230V/50Hz

RÖHREN TERM2000 IP65/IP67

BEZEICHNUNG	LEISTUNG	CODE	EAN	IP ANGABE	ABMESSUNGEN (Länge in cm)	GEWICHT (in g)	KABELLÄNGE	STROM- ANSCHLUSS
IP65/67 Cable 380 mm	1,0 kW	LG1001	4260051486185	IP65/67	38	50	300 mm and 920 mm, Wire-end sleeves	1/N/PE ~ 230V/50Hz
IP65/67 Cable 380 mm	1,7 kW	LGS1700V	4260051485973	IP65/67	38	50	300 mm and 920 mm, Wire-end sleeves	1/N/PE ~ 230V/50Hz
IP65/67 Cable 529 mm	1,65 kW	LG1650	4260051486093	IP65/67	52,9	50	300 mm and 920 mm, Wire-end sleeves	1/N/PE ~ 230V/50Hz
IP65/67 Cable 529 mm	2,0 kW	LG2001V	4260051486109	IP65/67	52,9	50	300 mm and 920 mm, Wire-end sleeves	1/N/PE ~ 230V/50Hz
IP65/67 Cable 380 mm	1,0 kW	ULG1001V	4260051485508	IP65/67	38	50	300 mm and 920 mm, Wire-end sleeves	1/N/PE ~ 230V/50Hz
IP65/67 Cable 529 mm	1,5 kW	ULG1500V	4260051485430	IP65/67	52,9	50	300 mm and 920 mm, Wire-end sleeves	1/N/PE ~ 230V/50Hz
IP65/67 Cable 529 mm	1,65 kW	ULG1650V	4260051484105	IP65/67	52,9	50	300 mm and 920 mm, Wire-end sleeves	1/N/PE ~ 230V/50Hz
IP65/67 Cable 529 mm	2,0 kW	ULG2001V	4260051484112	IP65/67	52,9	50	300 mm and 920 mm, Wire-end sleeves	1/N/PE ~ 230V/50Hz

RÖHREN BH SMART & R7S IP20

BEZEICHNUNG	LEISTUNG	CODE	EAN	IP ANGABE	ABMESSUNGEN (Länge in cm)	GEWICHT (in g)	KABELLÄNGE	STROM- ANSCHLUSS
R7S Push-In 254 mm	0,8 kW	LGHR800V	4260051488189	IP20	25,4	50	Wire-end sleeves	1/N/PE ~ 230V/50Hz
R7S Push-In 254 mm	1,0 kW	LGHR1000V	4260051488035	IP20	25,4	50	Wire-end sleeves	1/N/PE ~ 230V/50Hz
R7S Push-In 254 mm	1,3 kW	LGHR1300V	4260051488073	IP20	25,4	50	Wire-end sleeves	1/N/PE ~ 230V/50Hz
R7S Push-In 254 mm	1,3 kW	ULGR1300V	4260051484143	IP20	25,4	50	Wire-end sleeves	1/N/PE ~ 230V/50Hz

RÖHREN BH SMART SK15 IP20/IP24

BEZEICHNUNG	LEISTUNG	CODE	EAN	IP ANGABE	ABMESSUNGEN (Länge in cm)	GEWICHT (in g)	KABELLÄNGE	STROM- ANSCHLUSS
IP20 Cable 350 mm	1,5 kW	LGHS1500V	4260051484877	IP20		50	300 mm double-sided, Wire-end sleeves	1/N/PE ~ 230V/50Hz
IP20 Cable 350 mm	2,0 kW	LGHS2000	4260051488103	IP20		50	300 mm double-sided, Wire-end sleeves	1/N/PE ~ 230V/50Hz
IP24 Cable 350 mm	1,5 kW	LGHS1524V	4260051480770	IP24		50	590 mm and 240 mm, Wire-end sleeves	1/N/PE ~ 230V/50Hz
IP24 Cable 350 mm	2,0 kW	LGHS2024	4260051489605	IP24		50	590 mm and 240 mm, Wire-end sleeves	1/N/PE ~ 230V/50Hz

What is infrared?

SUCCESS WITH THE INTELLIGENT TECHNOLOGY

Infrared short-wave technology: Infrared radiation is a sub-area of the light spectrum generated by the sun. This type of light, however, is invisible to the human eye; it only serves to radiate heat. Basically: the shorter the wavelength, the easier it is to penetrate the air. Short-wave infrared generates heat by heating the object it meets with, without heating the air around it. Even effective and instant heat without pre-heating. A good example for this mode of action is the effect that occurs when a person walks out of the shade into the sunlight. Although the ambient temperature remains the same, they feel the temperature as considerably warmer under direct solar radiation. Economically, environmentally convincing and cost-saving for more advantages.

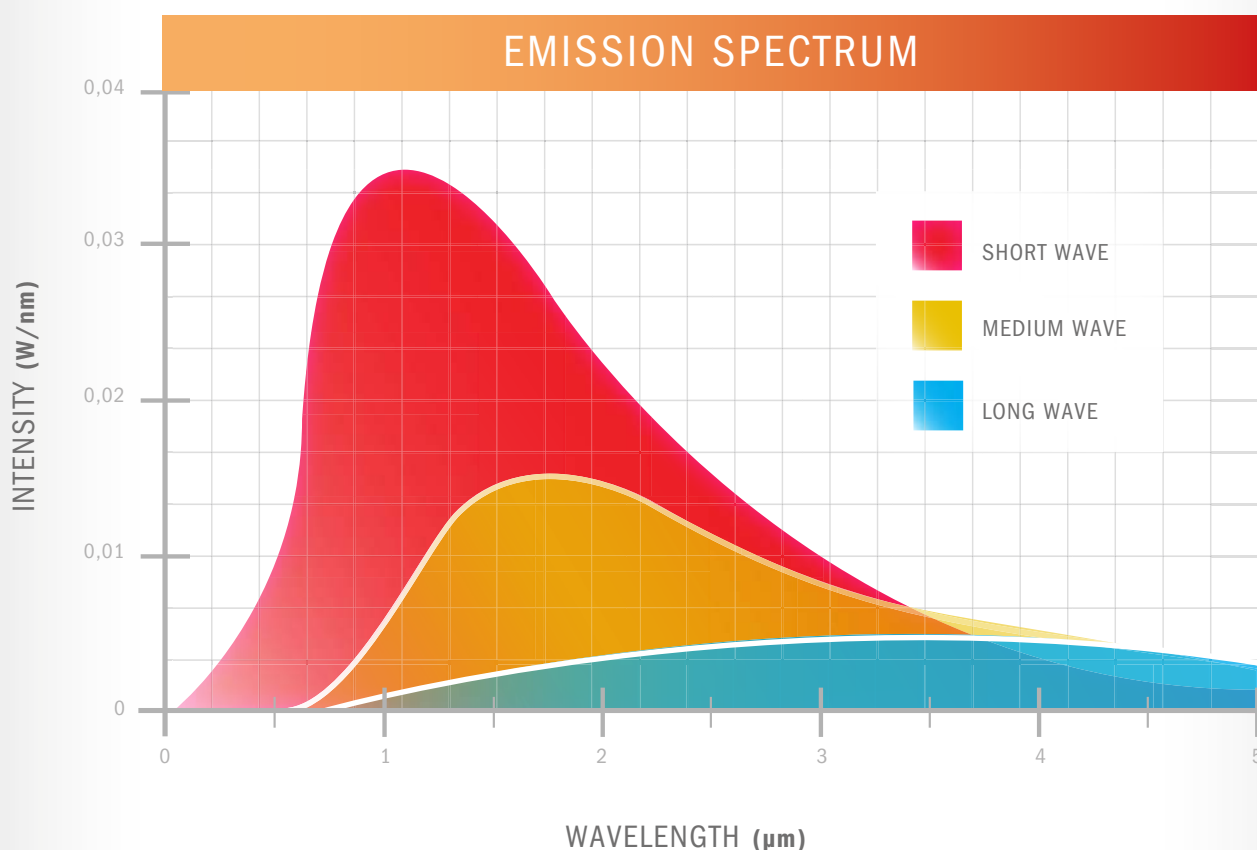

EVEN BETTER THAN BEFORE – LOW GLARE BECOMES ULTRA LOW GLARE

Low Glare has now become Ultra Low Glare – we have succeeded in further developing the tried and tested Low Glare tubular radiators in such a way that we have been able to lessen not only the red light, which is indispensable in infrared technology, but also the tube's glare. Thanks to a double coating inside and outside the heating tubes, we have been able to prevent light emission by up to 80%. This leaves a soft light which does not affect other light sources, for example patios and balconies, in the surrounding area. Ultra Low Glare products offer a compelling combination of the effective heating power of infrared short-wave technology and an ideal light source for a pleasant candle-lit atmosphere. Ultra Low Glare is now installed in all Burda TERM 2000 versions IP24, IP44, IP65 and IP67 radiator series as well as in all PerfectClime radiators.



Good to know

TERM 2000 HEAT FOOTPRINT
WITH 45° INSTALLATION ANGLE

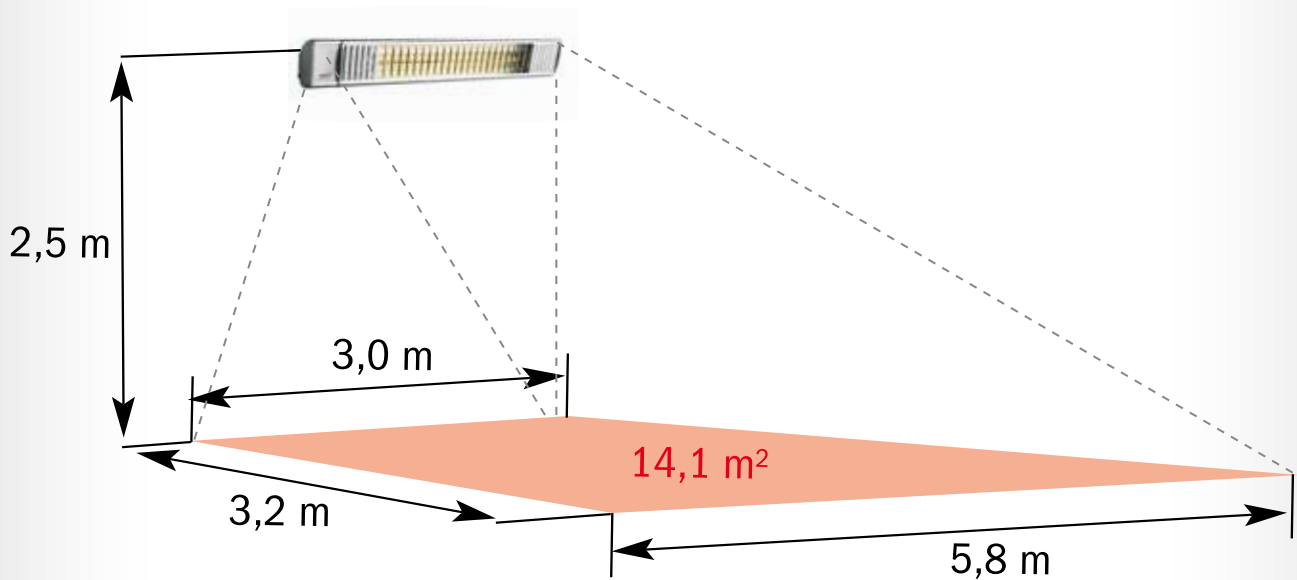

GAS DEVICE

Short operation time

Traditional gas patio heaters use 11 kg gas bottles, which have to be changed after **8-11 hours**.

11 kg bottle propan gas: 20 €

Consumption 1 kg/h:

Cost per hour = 1,81 €

BURDA RADIANT HEATER

Long operation time

Infrared short-wave radiant heaters only need a new heating bulb after **some 5.000 working hours**.

2 kW electr. supply at actual price = 2 x 0,24 €:

2.000 W radiant heater:

Cost per hour = 0,48 €

Saving per hour =

1,33 € or more than 70%

With same operating cost

= 3-4 BURDA radiant heaters

= 1 Gas patio heater

Instant heat for 14 – 16 m² with 1.500 – 2.000 W for 36 – 48 cent per hour



Your dealer

INTELLIGENT DECISIONS!

Our clients value the outstanding quality and the broad range of application of our products. Whether in the hotel or catering industry or in private areas the BURDA infrared short-wave technology heater and cooler product range convinces the world leading brands and industries (MS Europa, the best cruise liner in the world). Choose the intelligent solutions to your needs.

SELECTION OF REFERENCES

International Cooperation

- AEG/Stiebel Eltron
- Bartscher
- Schwank

Worldwide first class hotels

- Adlon
- Holiday Inn
- Hilton
- Marriott
- Sheraton
- Steigenberger
- The Century
- Vier Jahreszeiten ...

International and national restaurants and cafes

- Blockhouse Steakhäuser
- Burger King
- Cafetiero
- Häagen-Dazs
- Hard Rock Cafe
- Le Crobag
- McDonald's
- Nordsee
- Starbucks ...

Superior grandhotel at sea

- AIDA Cruises
- A-Rosa Cruises
- Celebrity Cruises
- MS Europa (Das Traumschiff)

TV-Studio

- Big Brother
- Endemol

Museum and events

- Louvre Paris – Frankreich
- Berlinale Berlin – Deutschland

Trade and industry

- Areva
- Ford
- Mercedes
- Thyssen Krupp
- Volkswagen ...

Air Traffic

- Air Berlin
- Condor
- Lufthansa
- Royal Air Force
- US Army ...

BURDA WORLDWIDE TECHNOLOGIES GMBH

Rudolf-Diesel-Strasse 18 · 65760 Eschborn, Germany
Tel +49 6173 /324 24 0 · Fax +49 6173 /324 24 24
E-Mail info@burdawtg.com · www.burdawtg.com

Visit our Heating &
Cooling website
www.PerfectClimate.com



Visit our American website
www.TheHeater.com