

For a perfect climate

# The innovative **Heating**, **Cooling** and **Lighting** range



Awarded with the Innovation Prize R+T 2018

**MODULAR SYSTEM**



**OUTDOOR**

**INDOOR**

**MODULAR**



**NEW** **RELAX GLASS**  
IRA IP65, S. 18

**NEW** **RELAX DARK**  
IRC IP55, S.22

**NEW** **PERFECTCLIME®**  
COOLING SETS, S. 32

Valid from October 2018.  
(Changes and errors excepted)

# HEATING COOLING

## BURDA PERFECTCLIME® – the intelligent way ... since 1990

### INTELLIGENT SOLUTIONS

As the pioneer in the field of infrared short-wave technology our unique expertise and experience enables us to move the technology forward. The innovative products we offer are the best evidence for intelligent solutions. Producing efficient, energy saving instant heating or cooling products is our passion. Customized solutions, perfectly attuned to people and the environment guarantees an almost unlimited range of uses.

### INTELLIGENT ANSWERS

We listen, identify and understand relevant customer needs to find the right answers together. It goes without saying that we are passionate, flexible, customer focused and reliable.

### INTELLIGENT REALIZED

Highest standards in the production process and the use of sophisticated materials represent BURDA's claim of always offering its customers only the very best in terms of high quality, design, functionality and high performance. This is the only way possible to set standards worldwide.

### INTELLIGENT ADVANTAGES

- Original since 1990
- Unique quality standard
- High quality processing and manufacturing depth
- High quality substance and components
- Increased durability and burning duration
- Efficiency straight to the point
- Emission-free and clean (depending on electricity mix)
- Broad power spectrum up to 18 kW
- Wide choice of colors and models
- High quality elegant design
- Long-lasting, weatherproof aluminum



# LIGHT CONTROL

## Intelligent applications



Hotel, bar and catering industry



Terrace



Halls (production, warehouse, trade fair, etc.)



Balcony/terrace/conservatories



Garages/factories



Hangars

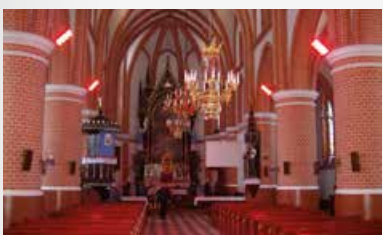

Churches



Live stock



Cruise ship

 Up from 2000 Watt we recommend to use 16amp slow blow fuses (C16).

PERFECTCLIME<sup>®</sup>

ULTRA  
LOW  
GLARE

100 % heat with  
80 % less light!

LOW  
GLARE

LIGHT

IP24 = Protection against  
splashing of water

IP44 = Splash-proof protection  
from all sides

IP65 = Protection against  
water-jets

IP67 = Protection against immersion,  
up to 1 m depth



**BURDA**  
PERFECTCLIME  
SINCE 1990

ALL FROM ONE  
**SOURCE**



**MODULAR SYSTEM**

PAGE 22 - 27

**INFRARED HEATER**

PAGE 6 - 21

**BLUETOOTH**

Bluetooth infrared heaters from BURDA PERFECTCLIME® allow thermal control via Smartphone and tablet (iOS & Android) without cable.

**ULTRA LOW GLARE**

Equipped with innovative ULTRALOW GLARE technology BURDA PERFECTCLIME® presents eye-friendly, double-coated tubes with 80 percent less red light.

**COLOR**

Our proven COLOR models are available in white, black and anthracite as well as in many other RAL colors.

**MODULAR**

System solution with heating, light and cooling elements available in each length, feature and color.

**HEATING & COOLING**

Our patented PERFECTCLIME® models are additionally equipped with cooling nozzles, atomize the finest water mist and ensure an immediate cooling of the temperature.

**LIGHT & HEAT**

The combination of proven infrared cymbal technology with the patented lighting option (LEDs) from BURDA PERFECTCLIME® ensures pleasant instant warmth with effective light effects.

**NEW**

**NEW**  
NEW EDITION

**NEW**

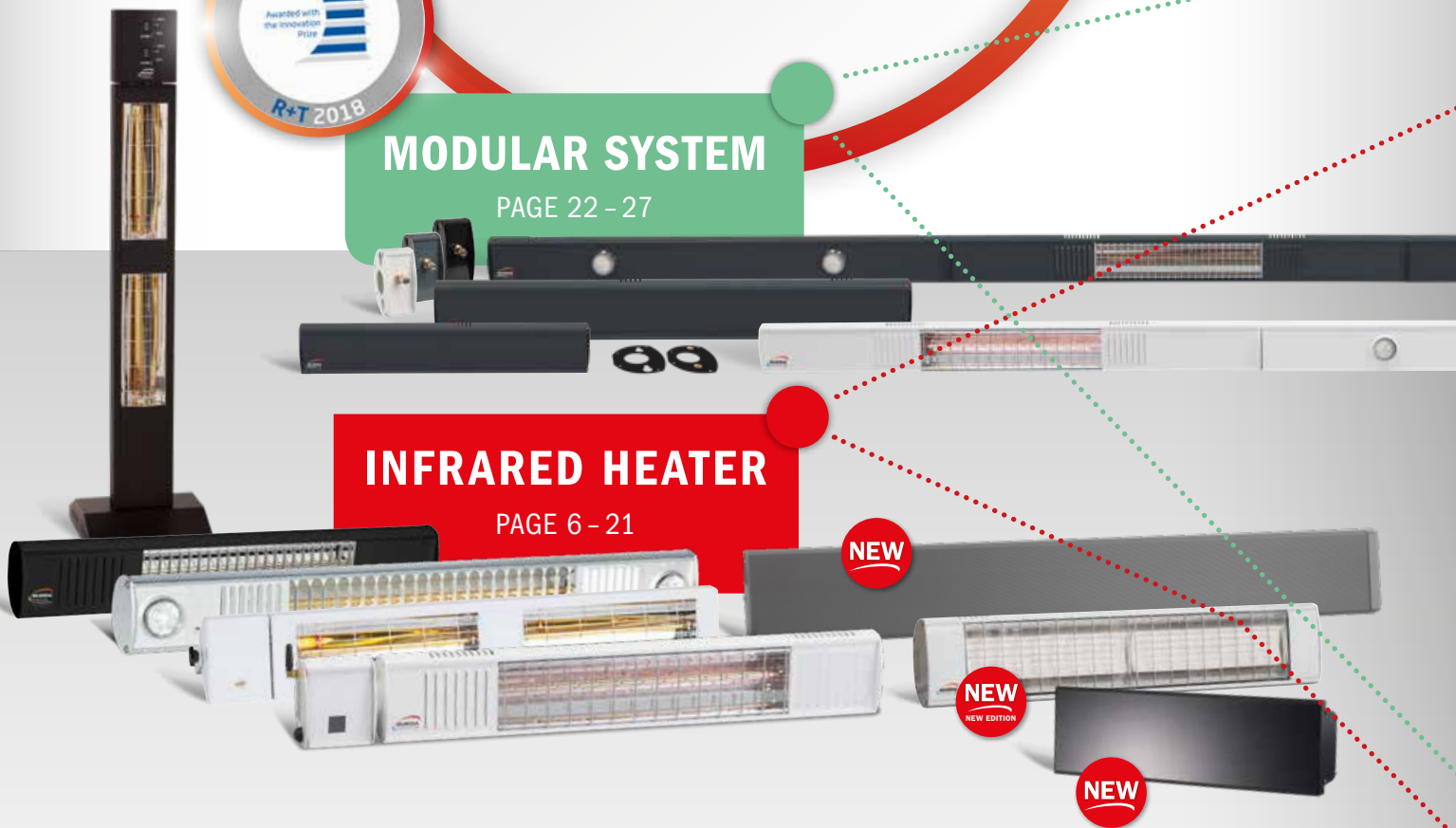



**DIMMER**



**CONTROL**

BLUETOOTH, CABLE,  
RADIO TRANSMITTER  
PAGE 33-35



**THERMOSTATS**

**HEATPANELS**

PAGE 39-47



**PERFECTCLIME®**

PAGE 28-32



**MOUNTING SYSTEMS**

PAGE 36-38





## BLUETOOTH

OUTDOOR

Discover the new Burda Bluetooth products for a wireless regulation via Smartphone with the Burda App! On the one hand we have the BURDA PERFECTCLIME® **Bluetooth Heater** and on the other hand the **Bluetooth Dimmer** with whom you can control your heaters with the free **BURDA App** or by the remote control included.



### APPLICATIONS

In all private, gastronomic, commercial, public or industrial outdoor areas



## BURDA App Control via Smartphones



To download the App please scan the QR-Code.

For free for Android and iOS devices.

- ✓ Regulation for up to eight heaters
- ✓ Range: 50 m (no line of sight required)
- ✓ Timer function



Available for Burda Control and Heating systems





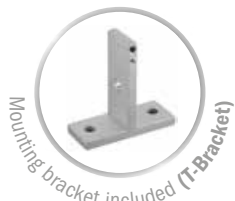

2 kW

71 cm



INFRARED HEATER

## TERM2000 BLUETOOTH IP67

Slow blow fuse 16 Amp (C16) recommended



### Remote Control included

For an easy control of your Bluetooth heater or dimmer without smartphone.

- ✓ App control via smartphone
- ✓ Integrated switch for manual operation
- ✓ Colors: Anthracite, white and black
- ✓ Ultra Low Glare
- ✓ Waterproof IP67



POWER (in watt)	MATERIAL/COLOR	CODE	EAN	IP PROTECTION CLASS	DIMENSIONS (W x H x D in cm)	WEIGHT (in g)	CABLE	CONNECTION
2000	White	BTURCAC200V9010	4260409692442	IP67	71 x 10 x 12.5	2500	1.9 m 3-wire 1.5 mm <sup>2</sup> , Schuko plug	1/N/PE ~ 230 V 50 Hz
2000	Anthracite	BTURCAC200V7016	4260409692459	IP67	71 x 10 x 12.5	2500	1.9 m 3-wire 1.5 mm <sup>2</sup> , Schuko plug	1/N/PE ~ 230 V 50 Hz
2000	Black	BTURCAC200V9005	4260409692435	IP67	71 x 10 x 12.5	2500	1.9 m 3-wire 1.5 mm <sup>2</sup> , Schuko plug	1/N/PE ~ 230 V 50 Hz



2 kW

- ✓ App control via smartphone
- ✓ Integrated switch for manual operation
- ✓ Colors: Silver, white and black
- ✓ Splash water protection IP24

### Remote Control included

For an easy control of your Bluetooth heater or dimmer without smartphone.

## SMART BLUETOOTH IP24

Slow blow fuse 16 Amp (C16) recommended



48 cm



POWER (in watt)	MATERIAL/COLOR	CODE	EAN	IP PROTECTION CLASS	DIMENSIONS (W x H x D in cm)	WEIGHT (in g)	CABLE	CONNECTION
2000	White	BTBHS2024	4260409693135	IP24	48 x 14.5 x 9.5	2500	1.9 m 3-wire 1.5 mm <sup>2</sup> , Schuko plug	1/N/PE ~ 230 V 50 Hz
2000	Black	BTBHS2024-1	4260409693142	IP24	48 x 14.5 x 9.5	2500	1.9 m 3-wire 1.5 mm <sup>2</sup> , Schuko plug	1/N/PE ~ 230 V 50 Hz
2000	Silver	BTBHS2024-3	4260409693159	IP24	48 x 14.5 x 9.5	2500	1.9 m 3-wire 1.5 mm <sup>2</sup> , Schuko plug	1/N/PE ~ 230 V 50 Hz



3 kW

- ✓ App control via smartphone
- ✓ Integrated switch for manual operation
- ✓ Colors: Silver, white and black
- ✓ Splash water protection IP24

89.5 cm



## SMART MULTI BLUETOOTH IP24

Slow blow fuse 16 Amp (C16) recommended



### Remote Control included

For an easy control of your Bluetooth heater or dimmer without smartphone



MULTIBRACKET INCLUDED

POWER (in watt)	MATERIAL/COLOR	CODE	EAN	IP PROTECTION CLASS	DIMENSIONS (W x H x D in cm)	WEIGHT (in g)	CABLE	CONNECTION
2 x 1500	White	BTBHS3024	4260409694064	IP24	89.5 x 14.5 x 9.5	4000	1.9 m 3-wire 1.5 mm <sup>2</sup> , Wire-end sleeves	1/N/PE ~ 230 V 50 Hz
2 x 1500	Black	BTBHS3024-1	4260409694071	IP24	89.5 x 14.5 x 9.5	4000	1.9 m 3-wire 1.5 mm <sup>2</sup> , Wire-end sleeves	1/N/PE ~ 230 V 50 Hz
2 x 1500	Silver	BTBHS3024-3	4260409694088	IP24	89.5 x 14.5 x 9.5	4000	1.9 m 3-wire 1.5 mm <sup>2</sup> , Wire-end sleeves	1/N/PE ~ 230 V 50 Hz



3 kW

## SMART TOWER BLUETOOTH IP24

Slow blow fuse 16 amp (C16) recommended



126 cm



- ✓ App control via smartphone
- ✓ Integrated switch for manual operation
- ✓ Colors: Silver, white and black
- ✓ Splash water protection IP24



### Remote Control included

For an easy control of your Bluetooth heater or dimmer without smartphone

POWER (in watt)	MATERIAL/COLOR	CODE	EAN	IP PROTECTION CLASS	DIMENSIONS (W x H x D in cm)	WEIGHT (in g)	CABLE	CONNECTION
2 x 1500	White	BTBHST3024-2	4260409694002	IP24	29 x 126 x 32	7300	1.9 m 3-wire 1.5 mm <sup>2</sup> , Schuko plug	1/N/PE ~ 230 V 50 Hz
2 x 1500	Black	BTBHST3024-1	4260409694026	IP24	29 x 126 x 32	7300	1.9 m 3-wire 1.5 mm <sup>2</sup> , Schuko plug	1/N/PE ~ 230 V 50 Hz
2 x 1500	Silver	BTBHS3024-3	4260409694019	IP24	29 x 126 x 32	7300	1.9 m 3-wire 1.5 mm <sup>2</sup> , Schuko plug	1/N/PE ~ 230 V 50 Hz



# TERM2000

OUTDOOR

The TERM2000-series has been designed to provide easy heating in outdoor areas. The heaters are fitted with a specially developed and manufactured infrared gold tube with a very high operating life of up to 5,000 hours. Depending on the application and the required power output, the TERM2000 is available in IP44 versions, and as a completely waterproof IP67-version.

All the advantages of the TERM2000-series are also available as freestanding versions: TERM TOWER PALMS! Ideal for hotels and restaurants, the TERM TOWER PALMS offers optimum heating power for all outdoor areas – particularly where other systems cannot be used because mounting is not possible.

There are many different configuration possibilities (i. e. light) which guarantee an infinite field of applications. Also available with table and ashtray.

## APPLICATIONS

In all private, gastronomic, commercial, public or industrial outdoor areas



TERM TOWER PALMS IP67



TERM2000 IP44

TERM2000 IP67





- 1 kW
- 1.5 kW
- 1.65 kW
- 2 kW



## TERM2000 IP67 & TERM2000 COLOR IP67

Available and combinable with:

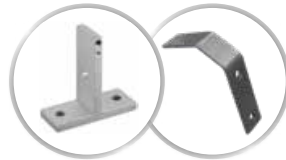

Mounting bracket included  
Aluminum-Color-Heater: **T-Bracket**  
Aluminum-Heater: **L-Bracket**

45 cm - 61 cm

POWER (in watt)	MATERIAL/COLOR	CODE	EAN	IP PROTECTION CLASS	DIMENSIONS (W x H x D in cm)	WEIGHT (in g)	CABLE	CONNECTION
1000	Polished aluminum	RCA100	4260051480503	IP67	45 x 9.5 x 12.5	2000	1.9 m 3-wire 1.5 mm², Schuko plug	1/N/PE ~ 230 V 50 Hz
1650	Polished aluminum	RCA165	4260051480237	IP67	61 x 9.5 x 12.5	2300	1.9 m 3-wire 1.5 mm², Schuko plug	1/N/PE ~ 230 V 50 Hz
2000	Polished aluminum	RCA200V	4260051480275	IP67	61 x 9.5 x 12.5	2300	1.9 m 3-wire 1.5 mm², Schuko plug	1/N/PE ~ 230 V 50 Hz
1000	Polished aluminum	URCA100V	4260051485577	IP67	45 x 9.5 x 12.5	2000	1.9 m 3-wire 1.5 mm², Schuko plug	1/N/PE ~ 230 V 50 Hz
1500	Polished aluminum	URCA150V	4260051485386	IP67	61 x 9.5 x 12.5	2300	1.9 m 3-wire 1.5 mm², Schuko plug	1/N/PE ~ 230 V 50 Hz
1650	Polished aluminum	URCA165V	4260051483863	IP67	61 x 9.5 x 12.5	2300	1.9 m 3-wire 1.5 mm², Schuko plug	1/N/PE ~ 230 V 50 Hz
2000	Polished aluminum	URCA200V	4260051484150	IP67	61 x 9.5 x 12.5	2300	1.9 m 3-wire 1.5 mm², Schuko plug	1/N/PE ~ 230 V 50 Hz
1500	White	URCAC150V9010	4260051485607	IP67	61 x 9.5 x 12.5	2000	1.9 m 3-wire 1.5 mm², Schuko plug	1/N/PE ~ 230 V 50 Hz
1650	White	URCAC165V9010	4260051485614	IP67	61 x 9.5 x 12.5	2000	1.9 m 3-wire 1.5 mm², Schuko plug	1/N/PE ~ 230 V 50 Hz
2000	White	URCAC200V9010	4260051485621	IP67	61 x 9.5 x 12.5	2000	1.9 m 3-wire 1.5 mm², Schuko plug	1/N/PE ~ 230 V 50 Hz
1500	Black	URCAC150V9005	4260051486222	IP67	61 x 9.5 x 12.5	2000	1.9 m 3-wire 1.5 mm², Schuko plug	1/N/PE ~ 230 V 50 Hz
1650	Black	URCAC165V9005	4260051486239	IP67	61 x 9.5 x 12.5	2000	1.9 m 3-wire 1.5 mm², Schuko plug	1/N/PE ~ 230 V 50 Hz
2000	Black	URCAC200V9005	4260051486246	IP67	61 x 9.5 x 12.5	2000	1.9 m 3-wire 1.5 mm², Schuko plug	1/N/PE ~ 230 V 50 Hz
1500	Anthracite	URCAC150V7016	4260051488240	IP67	61 x 9.5 x 12.5	2000	1.9 m 3-wire 1.5 mm², Schuko plug	1/N/PE ~ 230 V 50 Hz
1650	Anthracite	URCAC165V7016	4260051488257	IP67	61 x 9.5 x 12.5	2000	1.9 m 3-wire 1.5 mm², Schuko plug	1/N/PE ~ 230 V 50 Hz
2000	Anthracite	URCAC200V7016	4260051486581	IP67	61 x 9.5 x 12.5	2000	1.9 m 3-wire 1.5 mm², Schuko plug	1/N/PE ~ 230 V 50 Hz



- 3.3 kW
- 4 kW
- 4.95 kW
- 6 kW

## TERM2000 MULTI IP67

Available and combinable with:



123.5 cm

Mounting bracket included (L-Bracket)



POWER (in watt)	MATERIAL/COLOR	CODE	EAN	IP PROTECTION CLASS	DIMENSIONS (W x H x D in cm)	WEIGHT (in g)	CABLE	CONNECTION
2 x 1650	Polished aluminum	RCJ330	4260051480435	IP67	123.5 x 9.5 x 12.5	4900	0.65 m 5-wire 1.5 mm <sup>2</sup> , Wire-end sleeves	2/N/PE ~ 230 (2N) V 50 Hz
2 x 2000	Polished aluminum	RCJ400V	4260051480442	IP67	123.5 x 9.5 x 12.5	4900	0.65 m 5-wire 1.5 mm <sup>2</sup> , Wire-end sleeves	2/N/PE ~ 230 (2N) V 50 Hz
2 x 1650	Polished aluminum	URCJ330V	4260051483870	IP67	123.5 x 9.5 x 12.5	4900	0.65 m 5-wire 1.5 mm <sup>2</sup> , Wire-end sleeves	2/N/PE ~ 230 (2N) V 50 Hz
2 x 2000	Polished aluminum	URCJ400V	4260051483887	IP67	123.5 x 9.5 x 12.5	4900	0.65 m 5-wire 1.5 mm <sup>2</sup> , Wire-end sleeves	2/N/PE ~ 230 (2N) V 50 Hz
3 x 1650	Polished aluminum	URCC495V	4260051483894	IP67	60 x 29 x 12.5	6800	0.65 m 5-wire 2.5 mm <sup>2</sup> , Wire-end sleeves	3/N/PE ~ 230(3N) V 50 Hz
3 x 2000	Polished aluminum	URCC600V	4260051483900	IP67	60 x 29 x 12.5	6800	0.65 m 5-wire 2.5 mm <sup>2</sup> , Wire-end sleeves	3/N/PE ~ 230(3N) V 50 Hz

Available with table and ashtray



- 3 kW
- 4 kW
- 6 kW
- 8 kW



## TERM TOWER PALMS IP67

Available and combinable with:

PERFECTCLIME®



POWER (in watt)	MATERIAL/COLOR	CODE	EAN	IP PROTECTION CLASS	DIMENSIONS (W x H x D in cm)	WEIGHT (in kg)	CABLE	CONNECTION
2 x 1.500	Polished aluminum	URTT300V	4260051488561	IP67	110 x 250-270	approx. 45	10 m 5-wire 2.5 mm <sup>2</sup> , Wire-end sleeves	3/N/PE ~ 400 (3N) V 50 Hz
2 x 2000	Polished aluminum	URTT400V	4260051483917	IP67	110 x 250-270	approx. 49	10 m 5-wire 2.5 mm <sup>2</sup> , Wire-end sleeves	3/N/PE ~ 400 (3N) V 50 Hz
3 x 2000	Polished aluminum	URTT600V	4260051483924	IP67	110 x 250-270	approx. 51	10 m 5-wire 2.5 mm <sup>2</sup> , Wire-end sleeves	3/N/PE ~ 400 (3N) V 50 Hz
4 x 2000	Polished aluminum	URTT800V	4260051483931	IP67	110 x 250-270	approx. 53	10 m 5-wire 2.5 mm <sup>2</sup> , Wire-end sleeves	3/N/PE ~ 400 (3N) V 50 Hz
2 x 1500	Black	URTT300V9005	4260051488578	IP67	110 x 250-270	approx. 49	10 m 5-wire 2.5 mm <sup>2</sup> , Wire-end sleeves	3/N/PE-400 (3N) V 50 Hz
2 x 2000	Black	URTT400V9005	4260051487779	IP67	110 x 250-270	approx. 49	10 m 5-wire 2.5 mm <sup>2</sup> , Wire-end sleeves	3/N/PE-400 (3N) V 50 Hz
3 x 2000	Black	URTT600V9005	4260051487786	IP67	110 x 250-270	approx. 51	10 m 5-wire 2.5 mm <sup>2</sup> , Wire-end sleeves	3/N/PE-400 (3N) V 50 Hz
4 x 2000	Black	URTT800V9005	4260051487793	IP67	110 x 250-270	approx. 53	10 m 5-wire 2.5 mm <sup>2</sup> , Wire-end sleeves	3/N/PE-400 (3N) V 50 Hz
2 x 1500	White	URTT300V9010	4260051488585	IP67	110 x 250-270	approx. 49	10 m 5-wire 2.5 mm <sup>2</sup> , Wire-end sleeves	3/N/PE-400 (3N) V 50 Hz
2 x 2000	White	URTT400V9010	4260051488196	IP67	110 x 250-270	approx. 49	10 m 5-wire 2.5 mm <sup>2</sup> , Wire-end sleeves	3/N/PE-400 (3N) V 50 Hz
3 x 2000	White	URTT600V9010	4260051488202	IP67	110 x 250-270	approx. 51	10 m 5-wire 2.5 mm <sup>2</sup> , Wire-end sleeves	3/N/PE-400 (3N) V 50 Hz
4 x 2000	White	URTT800V9010	4260051488219	IP67	110 x 250-270	approx. 53	10 m 5-wire 2.5 mm <sup>2</sup> , Wire-end sleeves	3/N/PE-400 (3N) V 50 Hz
Table	Black Werzalit	RTTT	4260051480589		59 x 2.3 x 59	4,16	10 m 5-wire 2.5 mm <sup>2</sup> , Wire-end sleeves	3/N/PE-400 (3N) V 50 Hz
Ashtray	Polished aluminum	RTTA	4260051480596		6 x 12.5 x 6	1	10 m 5-wire 2.5 mm <sup>2</sup> , Wire-end sleeves	3/N/PE-400 (3N) V 50 Hz

46.4 cm

- 1 kW
- 1.5 kW



## TERM2000 COLOR SHORT IP44



All colors available!

POWER (in watt)	MATERIAL/COLOR	CODE	EAN	IP PROTECTION CLASS	DIMENSIONS (W x H x D in cm)	WEIGHT (in g)	CABLE	CONNECTION
1000	White	URCACS01044V9010	4260051488592	IP44	46.4 x 9.5 x 12.5	2100	1.9 m 3-wire 1.5 mm <sup>2</sup> , Schuko plug	1/N/PE ~ 230 V 50 Hz
1500	White	URCACS01544V9010	4260051488370	IP44	46.4 x 9.5 x 12.5	2100	1.9 m 3-wire 1.5 mm <sup>2</sup> , Schuko plug	1/N/PE ~ 230 V 50 Hz
1000	Black	URCACS01044V9005	4260051488608	IP44	46.4 x 9.5 x 12.5	2100	1.9 m 3-wire 1.5 mm <sup>2</sup> , Schuko plug	1/N/PE ~ 230 V 50 Hz
1500	Black	URCACS01544V9005	4260051488394	IP44	46.4 x 9.5 x 12.5	2100	1.9 m 3-wire 1.5 mm <sup>2</sup> , Schuko plug	1/N/PE ~ 230 V 50 Hz
1000	Anthracite	URCACS01044V7016	4260051488615	IP44	46.4 x 9.5 x 12.5	2100	1.9 m 3-wire 1.5 mm <sup>2</sup> , Schuko plug	1/N/PE ~ 230 V 50 Hz
1500	Anthracite	URCACS01544V7016	4260051488424	IP44	46.4 x 9.5 x 12.5	2100	1.9 m 3-wire 1.5 mm <sup>2</sup> , Schuko plug	1/N/PE ~ 230 V 50 Hz

1 kW

1.5 kW

51 cm



## TERM2000 IP44



POWER (in watt)	MATERIAL/COLOR	CODE	EAN	IP PROTECTION CLASS	DIMENSIONS (W x H x D in cm)	WEIGHT (in g)	CABLE	CONNECTION
1000	Polished aluminum	URCA01044V	4260051488653	IP44	51 x 9.5 x 12.5	2300	1.9 m 3-wire 1.5 mm <sup>2</sup> , Schuko plug	1/N/PE ~ 230 V 50 Hz
1500	Polished aluminum	URCA01544V	4260051488509	IP44	51 x 9.5 x 12.5	2300	1.9 m 3-wire 1.5 mm <sup>2</sup> , Schuko plug	1/N/PE ~ 230 V 50 Hz

**INDOOR:** For indoor use of all models, the external control BPIRF (wireless), BHCINSTAT+3R (wired) or BHCFIT3R (wired) or equivalent must be used to comply with EU Regulation 2015/1188. Otherwise the device loses the CE mark.

0.65 kW

1.3 kW

1.95 kW

35.7 cm

60.7 cm

85.5 cm



## TERM2000 NO GLARE IP20



POWER (in watt)	MATERIAL/COLOR	CODE	EAN	IP PROTECTION CLASS	DIMENSIONS (W x H x D in cm)	WEIGHT (in g)	CABLE	CONNECTION
650	White	NRCA065	4260051488523	IP20	35,7 x 12,5 x 8	3000	1,9 m 3-wire 1,5 mm <sup>2</sup> , Schuko plug	1/N/PE ~ 230 V 50 Hz
650	Black	NRCA065-1	4260051488530	IP20	35,7 x 12,5 x 8	3000	1,9 m 3-wire 1,5 mm <sup>2</sup> , Schuko plug	1/N/PE ~ 230 V 50 Hz
2 x 650	White	NRCJ130	4260051488554	IP20	60,7 x 12,5 x 8	3000	1,9 m 3-wire 1,5 mm <sup>2</sup> , Schuko plug	1/N/PE ~ 230 V 50 Hz
2 x 650	Black	NRCJ130-1	4260051488547	IP20	60,7 x 12,5 x 8	3000	1,9 m 3-wire 1,5 mm <sup>2</sup> , Schuko plug	1/N/PE ~ 230 V 50 Hz
3 x 650	White	NRCK195	4260051488677	IP20	85,5 x 12,5 x 8	3000	1,9 m 3-wire 1,5 mm <sup>2</sup> , Schuko plug	1/N/PE ~ 230 V 50 Hz
3 x 650	Black	NRCK195-1	4260051488684	IP20	85,5 x 12,5 x 8	3000	1,9 m 3-wire 1,5 mm <sup>2</sup> , Schuko plug	1/N/PE ~ 230 V 50 Hz



2 kW



## TERM2000 CVH IP20

Infrared lacquer or building dryer -  
Multifunctional, portable dryer for material heating and drying



POWER (in watt)	MATERIAL/COLOR	CODE	EAN	IP PROTECTION CLASS	DIMENSIONS (W x H x D in cm)	WEIGHT (in g)	CABLE	CONNECTION
2000	Black	RCAC020VH-1	4260051482293	IP20	42.5 x 15 x 21	1500	1.9 m 3-wire 1.5 mm <sup>2</sup> , Schuko plug	1/N/PE ~ 230 V 50 Hz
2000	Red	RCAC020VH-4	4260051482309	IP20	42.5 x 15 x 21	1500	1.9 m 3-wire 1.5 mm <sup>2</sup> , Schuko plug	1/N/PE ~ 230 V 50 Hz





# LIGHT & HEAT

OUTDOOR

Wherever the "right" brightness is important, our heating/light combination devices should be your first choice. In technology and design they are based on the tried TERM2000-series in combination with 2- and 4-beam LED spots (240V/3.5 Watt). The devices are waterproof according to IP65, heating and light are separately controllable and dimmable optionally – specially tuned dimmers are also available as accessories.

## APPLICATIONS

In all private, gastronomic, commercial, public or industrial outdoor areas







1.65 kW + 7 W (LEDs)

2.0 kW+ 7 W (LEDs)

78 cm



## TERM2000 L&H FIX IP65 LED

Available and combinable with:

PERFECTCLIME®



POWER (in watt)	MATERIAL/COLOR	CODE	EAN	IP PROTECTION CLASS	DIMENSIONS (W x H x D in cm)	WEIGHT (in g)	CABLE	CONNECTION
1650 + 7	Polished aluminum	URLH1765F	4260051484044	IP65	78 x 9.5 x 12.5	3350	2 m 5-wire 1.5 mm <sup>2</sup> , Wire-end sleeves	2/N/PE ~ 230 V 50 Hz
2000 + 7	Polished aluminum	URLH2165F	4260051484051	IP65	78 x 9.5 x 12.5	3350	2 m 5-wire 1.5 mm <sup>2</sup> , Wire-end sleeves	2/N/PE ~ 230 V 50 Hz



1.65 kW + 7 W (LEDs)

2.0 kW+ 7 W (LEDs)

82.5 cm



180°

## TERM2000 L&H IP65 LED

Available and combinable with:

PERFECTCLIME®



POWER (in watt)	MATERIAL/COLOR	CODE	EAN	IP PROTECTION CLASS	DIMENSIONS (W x H x D in cm)	WEIGHT (in g)	CABLE	CONNECTION
1650 + 7	Polished aluminum	URLH1765	4260051484020	IP65	82.5 x 9.5 x 12.5	3350	1.9 m 5-wire 1.5 mm <sup>2</sup> , Wire-end sleeves	2/N/PE ~ 230 V 50 Hz
2000 + 7	Polished aluminum	URLH2165	4260051484037	IP65	82.5 x 9.5 x 12.5	3350	1.9 m 5-wire 1.5 mm <sup>2</sup> , Wire-end sleeves	2/N/PE ~ 230 V 50 Hz



200 cm

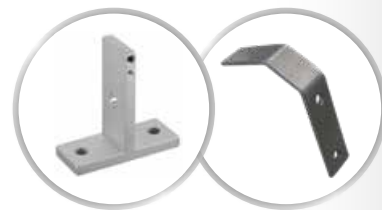

Mounting bracket included  
 aluminum colored heater: **T-Bracket**  
 aluminum polished heater: **L-Bracket**

## TERM2000 L&H XL IP65 LED

4.0 kW + 14 W (LEDs)

Available and combinable with:

PERFECTCLIME®



waterproof

POWER (in watt)	MATERIAL/ COLOR	CODE	EAN	IP PROTECTION CLASS	DIMENSIONS (W x H x D in cm)	WEIGHT (in g)	CABLE	CONNECTION
2 x 2000 + 14	Polished aluminum	URLH4265	4260051484075	IP65	200 x 9.5 x 12.5	7100	1.9 m 5-wire 2.5 mm <sup>2</sup> , Wire-end sleeves	3/N/PE ~ 400 V 50 Hz
2 x 2000 + 14	Anthracite	URLHC42657016	4260409692602	IP65	200 x 9.5 x 12.5	7100	1.9 m 5-wire 2.5 mm <sup>2</sup> , Wire-end sleeves	3/N/PE ~ 400 V 50 Hz
2 x 2000 + 14	White	URLHC42659010	4260409691575	IP65	200 x 9.5 x 12.5	7100	1.9 m 5-wire 2.5 mm <sup>2</sup> , Wire-end sleeves	3/N/PE ~ 400 V 50 Hz
2 x 2000 + 14	Black	URLHC42659005	4260409691582	IP65	200 x 9.5 x 12.5	7100	1.9 m 5-wire 2.5 mm <sup>2</sup> , Wire-end sleeves	3/N/PE ~ 400 V 50 Hz





# SMART

## OUTDOOR

The SMART-series presents uncomplicated and compact infrared heaters can be mounted on the wall, under the ceiling and on a tripod. The heaters can be installed as a standing heater (SMART TOWER) or as a flush mounted device for ceiling installation (SMART FRAME). The SMART-series provides immediate heat in all protected outdoor areas. All SMART models are equipped with light-reduced LOW GLARE-tubes with a low light output. The tubes guarantee up to 5000 hours of operation. You can choose between the standard colors white, black or silver.

### APPLICATIONS

In all private, gastronomic, commercial, public or industrial outdoor areas



- 1.5 kW
- 2 kW
- 3 kW
- 4 kW
- 6 kW



## SMART IP24 & SMART MULTI IP24

Available and combinable with:



(UL1278/UL2021)



Available with switch

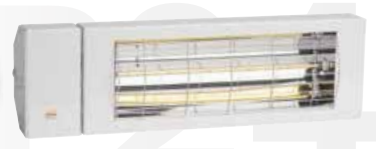

PERFECTCLIME®



POWER (in watt)	MATERIAL/COLOR	CODE	EAN	IP PROTECTION CLASS	DIMENSIONS (W x H x D in cm)	WEIGHT (in g)	CABLE	CONNECTION
1500	White	BHS1524	4260051489568	IP24	48 x 14,5 x 9,5	2500	1,9 m 3-wire 1,5 mm <sup>2</sup> , Schuko plug	1/N/PE ~ 230 V 50 Hz
1500	Silver	BHS1524-3	4260051489551	IP24	48 x 14,5 x 9,5	2500	1,9 m 3-wire 1,5 mm <sup>2</sup> , Schuko plug	1/N/PE ~ 230 V 50 Hz
2000	White	BHS2024	4260051489575	IP24	48 x 14,5 x 9,5	2500	1,9 m 3-wire 1,5 mm <sup>2</sup> , Schuko plug	1/N/PE ~ 230 V 50 Hz
2000	Silver	BHS2024-3	4260051489582	IP24	48 x 14,5 x 9,5	2500	1,9 m 3-wire 1,5 mm <sup>2</sup> , Schuko plug	1/N/PE ~ 230 V 50 Hz
2000	Black	BHS2024-1	4260051480053	IP24	48 x 14,5 x 9,5	2500	1,9 m 3-wire 1,5 mm <sup>2</sup> , Schuko plug	1/N/PE ~ 230 V 50 Hz
2 x 1500	White	BHS3024	4260051487243	IP24	89,5 x 14,5 x 9,5	4000	1,9 m 3-wire 1,5 mm <sup>2</sup> , Schuko plug	1/N/PE ~ 230 V/50 Hz
2 x 2000	White	BHS4024	4260051487267	IP24	89,5 x 14,5 x 9,5	4000	0,65 m 5-wire 2,5 mm <sup>2</sup> , Wire-end sleeves	2/N/PE ~ 230 V 50 Hz
3 x 2000	White	BHS6024	4260051487281	IP24	129 x 14,5 x 9,5	6000	0,65 m 5-wire 2,5 mm <sup>2</sup> , Wire-end sleeves	3/N/PE ~ 400 (3N) V 50 Hz
1500	White	BHSS1524	4260409694934	IP24	129 x 14,5 x 9,5	6000	0,65 m 5-wire 2,5 mm <sup>2</sup> , Wire-end sleeves	3/N/PE ~ 400 (3N) V 50 Hz
1500	Black	BHSS1524-1	4260409694941	IP24	129 x 14,5 x 9,5	6000	0,65 m 5-wire 2,5 mm <sup>2</sup> , Wire-end sleeves	3/N/PE ~ 400 (3N) V 50 Hz
1500	Silver	BHSS1524-3	4260409694958	IP24	129 x 14,5 x 9,5	6000	0,65 m 5-wire 2,5 mm <sup>2</sup> , Wire-end sleeves	3/N/PE ~ 400 (3N) V 50 Hz
2000	White	BHSS2024	4260409694965	IP24	129 x 14,5 x 9,5	6000	0,65 m 5-wire 2,5 mm <sup>2</sup> , Wire-end sleeves	3/N/PE ~ 400 (3N) V 50 Hz
2000	Black	BHSS2024-1	4260409694972	IP24	129 x 14,5 x 9,5	6000	0,65 m 5-wire 2,5 mm <sup>2</sup> , Wire-end sleeves	3/N/PE ~ 400 (3N) V 50 Hz
2000	Silver	BHSS2024-3	4260409694989	IP24	129 x 14,5 x 9,5	6000	0,65 m 5-wire 2,5 mm <sup>2</sup> , Wire-end sleeves	3/N/PE ~ 400 (3N) V 50 Hz



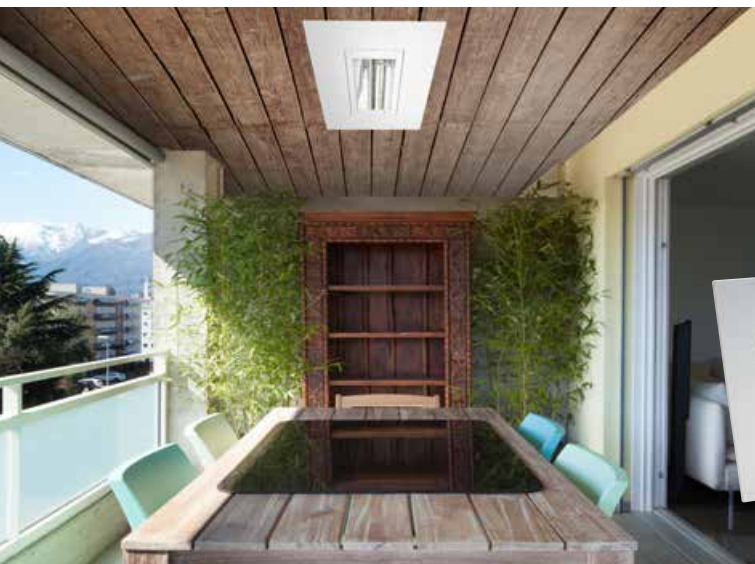

1.5 kW  
2 kW



INFRARED HEATER

## SMART FRAME IP24



POWER (in watt)	MATERIAL/COLOR	CODE	EAN	IP PROTECTION CLASS	DIMENSIONS (W x H x D in cm)	WEIGHT (in g)	CABLE	CONNECTION
1500	White	BHSF1524-2	4260409694842	IP24	60 x 32.5 x 10	3500	1.9 m 3-wire 1.5 mm <sup>2</sup> , Schuko plug	1/N/PE ~ 230 V 50 Hz
1500	Silver	BHSF1524-3	4260409694859	IP24	60 x 32.5 x 10	3500	1.9 m 3-wire 1.5 mm <sup>2</sup> , Schuko plug	1/N/PE ~ 230 V 50 Hz
2000	White	BHSF2024-2	4260409694835	IP24	60 x 32.5 x 10	3500	1.9 m 3-wire 1.5 mm <sup>2</sup> , Schuko plug	1/N/PE ~ 230 V 50 Hz
2000	Silver	BHSF2024-3	4260409694866	IP24	60 x 32.5 x 10	3500	1.9 m 3-wire 1.5 mm <sup>2</sup> , Schuko plug	1/N/PE ~ 230 V 50 Hz

126 cm



3 kW



## SMART TOWER IP24



POWER (in watt)	MATERIAL/COLOR	CODE	EAN	IP PROTECTION CLASS	DIMENSIONS (W x H x D in cm)	WEIGHT (in g)	CABLE	CONNECTION
2 x 1500	Black	BHST3024-1	4260051484686	IP24	29 x 126 x 32	7300	1.9 m 3-wire 1.5 mm <sup>2</sup> , Schuko plug	1/N/PE ~ 230 V 50 Hz
2 x 1500	White	BHST3024	4260051484693	IP24	29 x 126 x 32	7300	1.9 m 3-wire 1.5 mm <sup>2</sup> , Schuko plug	1/N/PE ~ 230 V 50 Hz
2 x 1500	Silver	BHST3024-3	4260051484709	IP24	29 x 126 x 32	7300	1.9 m 3-wire 1.5 mm <sup>2</sup> , Schuko plug	1/N/PE ~ 230 V 50 Hz
2 x 1500	Red	BHST3024-4	4260051484716	IP24	29 x 126 x 32	7300	1.9 m 3-wire 1.5 mm <sup>2</sup> , Schuko plug	1/N/PE ~ 230 V 50 Hz

All models\*  
are available for  
ceiling installation

\*except 2200 watt  
models

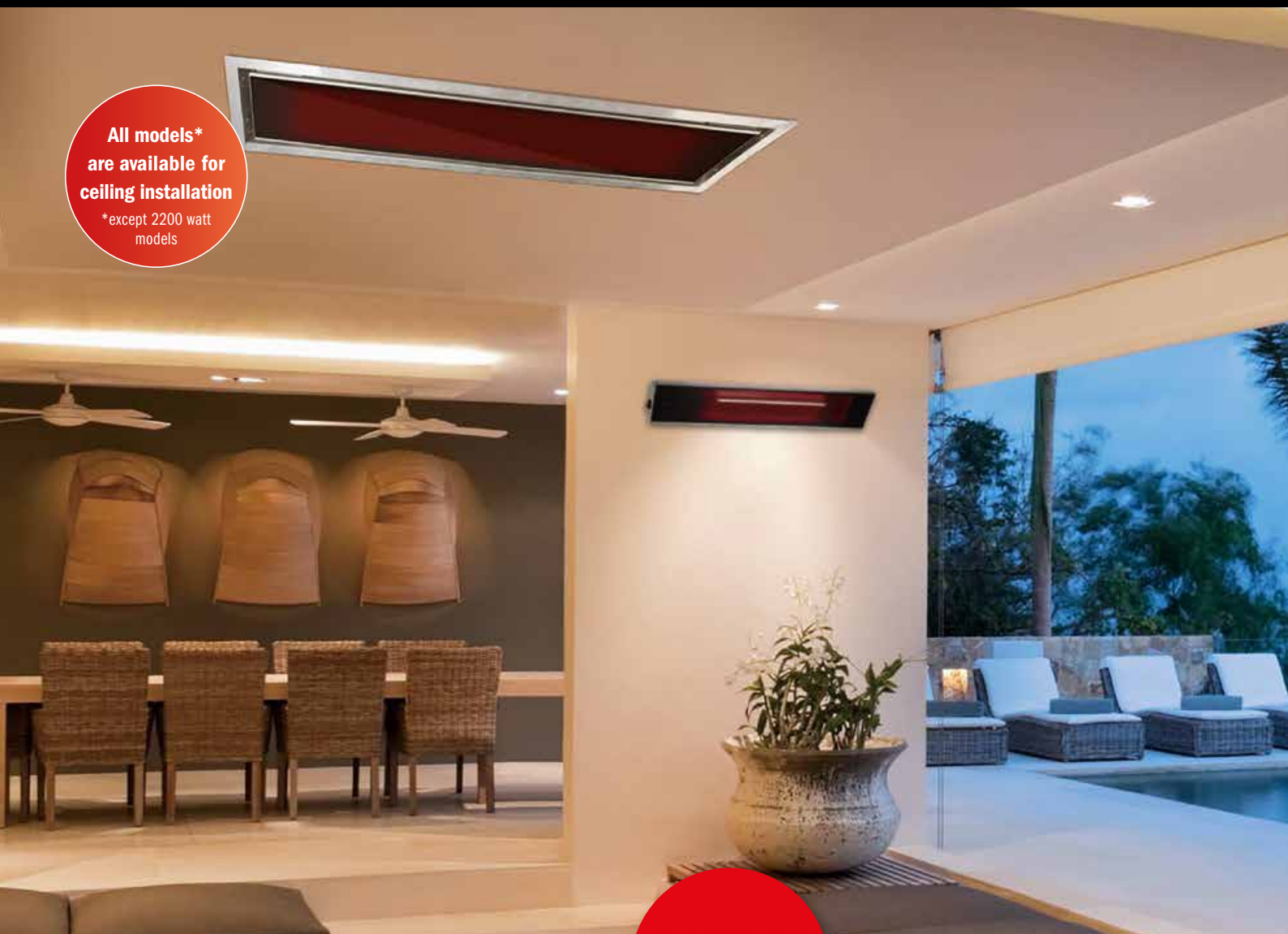

**NEW**

# RELAX!

## NEW PRODUCT LINE WITH HIGH PERFORMANCE INFRARED SHORT- AND LONG-WAVE HEATERS



The new product group from BURDA PERFECTCLIME® **RELAX!** presents powerful design infrared heaters with ceramic-glass front or completely without light. The new **RELAX!**-series includes the **RELAX GLASS IRA IP65** product line with very powerful infrared-short-wave heaters and light-reducing ceramic-glass covers **SCHOTT NEXTREMA®** for instant heat output. The range is supplemented with new dark heaters **RELAX DARK IRC IP55** for indoor areas. The long-wave radiators supply the circulating air evenly with warmth without any light effects.

### APPLICATIONS

In all private, gastronomic, commercial, public or industrial indoor and outdoor areas





## RELAX GLASS IRA IP65

With light-reducing SCHOTT NEXTREMA® ceramic glass

CASE COLORS



GLASS SCREEN



Very powerful short-wave heaters (IR-A) with a tinted ceramic-glass front SCHOTT NEXTREMA®. **RELAX GLASS IRA IP65** provide instant heat using short-wave radiation in the power range from 1200 to 2200 watt. The heater is waterproof and emits reduced light thanks to the high-quality ceramic glass screen. Ideal for wall and ceiling\* mounting, brackets included, or for flush-mounted ceiling installation with frame\*. The models are also available with a dimmer\*\* (33/66/100 %) and remote.

\* 2200 watt heater wall mounting only

\*\* 1200 watt heater ON/OFF remote only

- ✓ Infrared-short-wave with 1200/1500/1800 and 2200 watt for impressive instant heat
- ✓ High quality, light reducing ceramic-glass SCHOTT NEXTREMA®
- ✓ Waterproof, IP Protection Class IP65
- ✓ Color selection for case, glass and frame
- ✓ Optional with dimmer (33/66/100 %) including remote\*\*
- ✓ ON/OFF switch\*\*
- ✓ Power connection 230 Volt with C16A slow blow fuse
- ✓ 2-year guarantee

RELAX!

# IRA IP65

CODE*	EAN	POWER (in watt)	COLOR (Case/Glass)	IP PROTECTION CLASS	DIMENSIONS (W x H x D in cm)	WEIGHT (in g)	CABLE	CONNECTION
<b>With Dimmer/Remote</b>								
BRELG1200R-3	4260409695467	1200	Silver/Black	IP65	58.5 x 17 x 8	3600	1.8 m 3-wire 1.5 mm², Schuko plug	L/N/PE, 230-240 V ~ 50 Hz
BRELG1200R-3W	4260409695801	1200	Silver/White	IP65	58.5 x 17 x 8	3600	1.8 m 3-wire 1.5 mm², Schuko plug	L/N/PE, 230-240 V ~ 50 Hz
BRELG1200R-1	4260409695733	1200	Black/Black	IP65	58.5 x 17 x 8	3600	1.8 m 3-wire 1.5 mm², Schuko plug	L/N/PE, 230-240 V ~ 50 Hz
BRELG1500RD-3	4260409695443	1500	Silver/Black	IP65	90 x 17 x 8	5200	1.8 m 3-wire 1.5 mm², Schuko plug	L/N/PE, 230-240 V ~ 50 Hz
BRELG1500RD-3W	4260409695818	1500	Silver/White	IP65	90 x 17 x 8	5200	1.8 m 3-wire 1.5 mm², Schuko plug	L/N/PE, 230-240 V ~ 50 Hz
BRELG1500RD-1	4260409695450	1500	Black/Black	IP65	90 x 17 x 8	5200	1.8 m 3-wire 1.5 mm², Schuko plug	L/N/PE, 230-240 V ~ 50 Hz
BRELG1800RD-3	4260409695429	1800	Silver/Black	IP65	90 x 17 x 8	5200	1.8 m 3-wire 1.5 mm², Schuko plug	L/N/PE, 230-240 V ~ 50 Hz
BRELG1800RD-3W	4260409695825	1800	Silver/White	IP65	90 x 17 x 8	5200	1.8 m 3-wire 1.5 mm², Schuko plug	L/N/PE, 230-240 V ~ 50 Hz
BRELG1800RD-1	4260409695436	1800	Black/Black	IP65	90 x 17 x 8	5200	1.8 m 3-wire 1.5 mm², Schuko plug	L/N/PE, 230-240 V ~ 50 Hz
BRELG2200RD-3	4260409695405	2200	Silver/Black	IP65	90 x 17 x 8	5200	1.8 m 3-wire 1.5 mm², Schuko plug	L/N/PE, 230-240 V ~ 50 Hz
BRELG2200RD-3W	4260409695832	2200	Silver/White	IP65	90 x 17 x 8	5200	1.8 m 3-wire 1.5 mm², Schuko plug	L/N/PE, 230-240 V ~ 50 Hz
BRELG2200RD-1	4260409695412	2200	Black/Black	IP65	90 x 17 x 8	5200	1.8 m 3-wire 1.5 mm², Schuko plug	L/N/PE, 230-240 V ~ 50 Hz
<b>Without Dimmer/Remote</b>								
BRELG1200-3	4260409695399	1200	Silver/Black	IP65	58.5 x 17 x 8	3500	1.8 m 3-wire 1.5 mm², Schuko plug	L/N/PE, 230-240 V ~ 50 Hz
BRELG1200-3W	4260409695849	1200	Silver/White	IP65	58.5 x 17 x 8	3500	1.8 m 3-wire 1.5 mm², Schuko plug	L/N/PE, 230-240 V ~ 50 Hz
BRELG1200-1	4260409695757	1200	Black/Black	IP65	58.5 x 17 x 8	3500	1.8 m 3-wire 1.5 mm², Schuko plug	L/N/PE, 230-240 V ~ 50 Hz
BRELG1500-3	4260409695382	1500	Silver/Black	IP65	90 x 17 x 8	5100	1.8 m 3-wire 1.5 mm², Schuko plug	L/N/PE, 230-240 V ~ 50 Hz
BRELG1500-3W	4260409695856	1500	Silver/White	IP65	90 x 17 x 8	5100	1.8 m 3-wire 1.5 mm², Schuko plug	L/N/PE, 230-240 V ~ 50 Hz
BRELG1500-1	4260409695764	1500	Black/Black	IP65	90 x 17 x 8	5100	1.8 m 3-wire 1.5 mm², Schuko plug	L/N/PE, 230-240 V ~ 50 Hz
BRELG1800-3	4260409695375	1800	Silver/Black	IP65	90 x 17 x 8	5100	1.8 m 3-wire 1.5 mm², Schuko plug	L/N/PE, 230-240 V ~ 50 Hz
BRELG1800-3W	4260409695863	1800	Silver/White	IP65	90 x 17 x 8	5100	1.8 m 3-wire 1.5 mm², Schuko plug	L/N/PE, 230-240 V ~ 50 Hz
BRELG1800-1	4260409695771	1800	Black/Black	IP65	90 x 17 x 8	5100	1.8 m 3-wire 1.5 mm², Schuko plug	L/N/PE, 230-240 V ~ 50 Hz
BRELG2200-3	4260409695368	2200	Silver/Black	IP65	90 x 17 x 8	5100	1.8 m 3-wire 1.5 mm², Schuko plug	L/N/PE, 230-240 V ~ 50 Hz
BRELG2200-3W	4260409695870	2200	Silver/White	IP65	90 x 17 x 8	5100	1.8 m 3-wire 1.5 mm², Schuko plug	L/N/PE, 230-240 V ~ 50 Hz
BRELG2200-1	4260409695788	2200	Black/Black	IP65	90 x 17 x 8	5100	1.8 m 3-wire 1.5 mm², Schuko plug	L/N/PE, 230-240 V ~ 50 Hz

\* Agenda: Code-3: Case Silver + Glass Black | Code-3W: Case Silver + Glass White | Code-1: Case Black + Glass Black

# RELAX GLASS FRAME IRA IP65

With light-reducing SCHOTT NEXTREMA® ceramic glass



CASE COLORS



GLASS SCREEN



CODE*	EAN	POWER (in watt)	COLOR (Case/Glass)	IP PROTEC- TION CLASS	DIMENSIONS (W x H x D in cm)	WEIGHT (in g)	CABLE	CONNECTION
<b>With Dimmer/Remote</b>								
BRELGF1200R-3	4260409695597	1200	Silver/Black	IP65	60 x 21.5 x 8	5500	1.8 m 3-wire 1.5 mm², Schuko plug	L/N/PE, 230-240 V ~ 50 Hz
BRELGF1200R-3W	4260409695887	1200	Silver/White	IP65	60 x 21.5 x 8	5500	1.8 m 3-wire 1.5 mm², Schuko plug	L/N/PE, 230-240 V ~ 50 Hz
BRELGF1200R-1	4260409695603	1200	Black/Black	IP65	60 x 21.5 x 8	5200	1.8 m 3-wire 1.5 mm², Schuko plug	L/N/PE, 230-240 V ~ 50 Hz
BRELGF1500RD-3	4260409695610	1500	Silver/Black	IP65	97.5 x 23 x 8	8600	1.8 m 3-wire 1.5 mm², Schuko plug	L/N/PE, 230-240 V ~ 50 Hz
BRELGF1500RD-3W	4260409695894	1500	Silver/White	IP65	97.5 x 23 x 8	8600	1.8 m 3-wire 1.5 mm², Schuko plug	L/N/PE, 230-240 V ~ 50 Hz
BRELGF1500RD-1	4260409695627	1500	Black/Black	IP65	97.5 x 23 x 8	8300	1.8 m 3-wire 1.5 mm², Schuko plug	L/N/PE, 230-240 V ~ 50 Hz
BRELGF1800RD-3	4260409695634	1800	Silver/Black	IP65	97.5 x 23 x 8	8600	1.8 m 3-wire 1.5 mm², Schuko plug	L/N/PE, 230-240 V ~ 50 Hz
BRELGF1800RD-3W	4260409695900	1800	Silver/White	IP65	97.5 x 23 x 8	8600	1.8 m 3-wire 1.5 mm², Schuko plug	L/N/PE, 230-240 V ~ 50 Hz
BRELGF1800RD-1	4260409695641	1800	Black/Black	IP65	97.5 x 23 x 8	8300	1.8 m 3-wire 1.5 mm², Schuko plug	L/N/PE, 230-240 V ~ 50 Hz
<b>Without Dimmer/Remote</b>								
BRELGF1200-3	4260409695658	1200	Silver/Black	IP65	60 x 21.4 x 12.3	5500	1.8 m 3-wire 1.5 mm², Schuko plug	L/N/PE, 230-240 V ~ 50 Hz
BRELGF1200-3W	4260409695917	1200	Silver/White	IP65	60 x 21.4 x 12.3	5500	1.8 m 3-wire 1.5 mm², Schuko plug	L/N/PE, 230-240 V ~ 50 Hz
BRELGF1200-1	4260409695665	1200	Black/Black	IP65	60 x 21.4 x 12.3	5200	1.8 m 3-wire 1.5 mm², Schuko plug	L/N/PE, 230-240 V ~ 50 Hz
BRELGF1500-3	4260409695672	1500	Silver/Black	IP65	97.8 x 23.1 x 12.3	8600	1.8 m 3-wire 1.5 mm², Schuko plug	L/N/PE, 230-240 V ~ 50 Hz
BRELGF1500-3W	4260409695924	1500	Silver/White	IP65	97.8 x 23.1 x 12.3	8600	1.8 m 3-wire 1.5 mm², Schuko plug	L/N/PE, 230-240 V ~ 50 Hz
BRELGF1500-1	4260409695689	1500	Black/Black	IP65	97.8 x 23.1 x 12.3	8300	1.8 m 3-wire 1.5 mm², Schuko plug	L/N/PE, 230-240 V ~ 50 Hz
BRELGF1800-3	4260409695696	1800	Silver/Black	IP65	97.8 x 23.1 x 12.3	8600	1.8 m 3-wire 1.5 mm², Schuko plug	L/N/PE, 230-240 V ~ 50 Hz
BRELGF1800-3W	4260409695931	1800	Silver/White	IP65	97.8 x 23.1 x 12.3	8600	1.8 m 3-wire 1.5 mm², Schuko plug	L/N/PE, 230-240 V ~ 50 Hz
BRELGF1800-1	4260409695702	1800	Black/Black	IP65	97.8 x 23.1 x 12.3	8300	1.8 m 3-wire 1.5 mm², Schuko plug	L/N/PE, 230-240 V ~ 50 Hz

\* Agenda: Code-3: Case Silver + Glass Black | Code-3W: Case Silver + Glass White | Code-1: Case Black + Glass Black

## RELAX GLASS IRA IP65

CODE	EAN	COLOR	DESCRIPTION	MATERIAL	DIMENSIONS (W x H x D in cm)	WEIGHT (in g)
<b>Frame</b>						
BRELGF3-3	4260409695498	Silver	Frame for 1200 watt models	Stainless steel	60 x 21.4 x 12.3	2000
BRELGF3-1	4260409695795	Black	Frame for 1200 watt models	Cold-rolled steel	60 x 21.4 x 12.3	1700
BRELGF1-3	4260409695474	Silver	Frame for 1500/1800 watt models	Stainless steel	97.8 x 23.1 x 12.3	3500
BRELGF1-1	4260409695481	Black	Frame for 1500/1800 watt models	Cold-rolled steel	97.8 x 23.1 x 12.3	3200
<b>Remote</b>						
BRELGR	4260409695511	Black	Remote for 1200 watt models, ON/OFF function, Timer 1 h.	ABS	4.5 x 12.5	50
BRELGRD	4260409695504	Black	Remote for 1500/1800/2200 watt models with Dimmer (33/66/100 %) and Timer (3 h.)	ABS		50
<b>Mounting bracket</b>						
BRELGB-3	4260409695566	Silver	Mounting bracket	Stainless steel		450 g/set





## RELAX DARK IRC IP55

NO LIGHT with intelligent long-wave technology

COLOR

Silver

Black

Powerful dark heater without any light emission. The long-wave radiator **RELAX DARK IRC IP55** supplies the circulating air evenly with warmth without any light effects. The flat, linear design in silver or black fits elegant and discreet into any ambience. Simple elegance and high functionality offer a variety of applications in private and commercial indoor environments. Due to the long-wave IR radiation, only absolutely wind-free areas are suitable for outdoor efficiency.

**INDOOR:** For **indoor use** of all models up to 3600 watt, the external control BPIRF (wireless), BHCINSTAT+3R (wired) or BHCFIT3R (wired) or equivalent must be used to comply with EU Regulation 2015/1188. Otherwise the device loses the CE mark.

158 cm



- ✓ Infrared-long-wave IRC with 2200/2400 watt for comforting warmth
- ✓ NO light emission
- ✓ High quality, waterproof design IP55
- ✓ Colors Black and Silver
- ✓ Power connection 230 Volt with 16A fuse
- ✓ 2-year guarantee

IRC IP55

CODE	EAN	POWER (in watt)	COLOR	IP PROTECTION CLASS	DIMENSIONS (W x H x D in cm)	WEIGHT (in g)	CABLE	CONNECTION
BRELD2200-3	4260409695580	2200	Silver	IP55	158 x 20.1 x 5.8	8100	1.9 m 3-wire, 1.5 mm <sup>2</sup> , Schuko plug	220-240 V ~ 50-60 Hz
BRELD2400-1	4260409695573	2400	Black	IP55	158 x 20.1 x 5.8	8100	1.9 m 3-wire, 1.5 mm <sup>2</sup> , Schuko plug	220-240 V ~ 50-60 Hz



PATENTED



# MODULAR SYSTEM

OUTDOOR

## YOU HAVE THE CHOICE – COMPLETELY INDIVIDUAL OR STANDARD SETS

We adjust and combine according to your needs, wishes and design – easy and completely individual! Our unique and patented modular concept with heating, LED lights and cooling systems, offer individual combinations for every project: Together with awnings, conservatories, patio roofs, i. e. also for stadiums, exhibition halls, or just stand-alone on your balcony. Combine single modules or standard sets to every desired color and length – 10, 20, 30, 50 or 100 m, no problem! Choose from our standard colors pure white (9010), Black (9005) and anthracite (7016) or with a supplementary charge for an individual color of your choice. Mounting brackets are included. Whether single modules or standard modular sets, order now!

- ✓ MODULAR ✓ INDIVIDUAL ✓ EVERY LENGTH
- ✓ EVERY COLOR ✓ WATERPROOF IP65/67 ✓ LEDS WITH 3.5 W

### APPLICATIONS

In all private, gastronomic, commercial, public or industrial outdoor areas

Standard Colors:

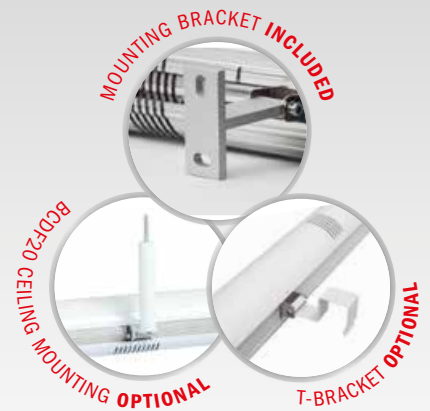



2 kW

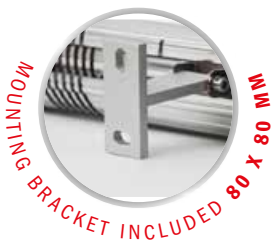

300 cm

**MSET 3.1** = M1 + M2 + M1

2 x LED + 1 x Heater



IP65

POWER (in watt)	MATERIAL/COLOR	CODE	EAN	IP PROTECTION CLASS	DIMENSIONS (W x H x D in cm)	WEIGHT (in g)	CABLE	CONNECTION
2000 + 14	White	MSET3.1 9010	4260409691636	IP65	300 x 9.5 x 12.5	7100	1 m 5-wire 1.5 mm <sup>2</sup> , Wieland plug	3/N/PE ~ 400 (3N) V 50 Hz
2000 + 14	Black	MSET3.1 9005	4260409692831	IP65	300 x 9.5 x 12.5	7100	1 m 5-wire 1.5 mm <sup>2</sup> , Wieland plug	3/N/PE ~ 400 (3N) V 50 Hz
2000 + 14	Anthracite	MSET3.1 7016	4260409691643	IP65	300 x 9.5 x 12.5	7100	1 m 5-wire 1.5 mm <sup>2</sup> , Wieland plug	3/N/PE ~ 400 (3N) V 50 Hz

MODULAR

4 kW

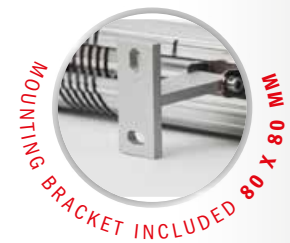

300 cm

**MSET 3.2** = M2 + M1 + M2

1 x LED + 2 x Heater



POWER (in watt)	MATERIAL/COLOR	CODE	EAN	IP PROTECTION CLASS	DIMENSIONS (W x H x D in cm)	WEIGHT (in g)	CABLE	CONNECTION
4000 + 7	White	MSET3.2 9010	4260409691858	IP65	300 x 9.5 x 12.5	7000	1 m 5-wire 1.5 mm <sup>2</sup> , Wieland plug	3/N/PE ~ 400 (3N) V 50 Hz
4000 + 7	Black	MSET3.2 9005	4260409692848	IP65	300 x 9.5 x 12.5	7000	1 m 5-wire 1.5 mm <sup>2</sup> , Wieland plug	3/N/PE ~ 400 (3N) V 50 Hz
4000 + 7	Anthracite	MSET3.2 7016	4260409691872	IP65	300 x 9.5 x 12.5	7000	1 m 5-wire 1.5 mm <sup>2</sup> , Wieland plug	3/N/PE ~ 400 (3N) V 50 Hz

6 kW

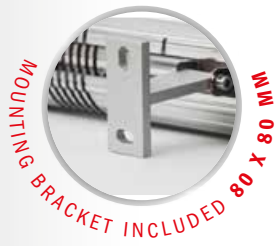

300 cm

MSET 3.3 = M2 + M2 + M2

3 x Heater

IP67



POWER (in watt)	MATERIAL/COLOR	CODE	EAN	IP PROTECTION CLASS	DIMENSIONS (W x H x D in cm)	WEIGHT (in g)	CABLE	CONNECTION
6000	White	MSET3.3 9010	4260409692657	IP67	300 x 9.5 x 12.5	6900	1 m 5-wire 1.5 mm <sup>2</sup> , Wieland plug	3/N/PE ~ 400 (3N) V 50 Hz
6000	Black	MSET3.3 9005	4260409692664	IP67	300 x 9.5 x 12.5	6900	1 m 5-wire 1.5 mm <sup>2</sup> , Wieland plug	3/N/PE ~ 400 (3N) V 50 Hz
6000	Anthracite	MSET3.3 7016	4260409692688	IP67	300 x 9.5 x 12.5	6900	1 m 5-wire 1.5 mm <sup>2</sup> , Wieland plug	3/N/PE ~ 400 (3N) V 50 Hz



4 kW

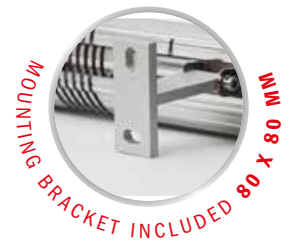

400 cm

MSET 4.1 = M1 + M2 + M2 + M1

2 x LED + 2 x Heater



POWER (in watt)	MATERIAL/COLOR	CODE	EAN	IP PROTECTION CLASS	DIMENSIONS (W x H x D in cm)	WEIGHT (in g)	CABLE	CONNECTION
4000 + 14	White	MSET4.1 9010	4260409692695	IP65	400 x 9.5 x 12.5	9400	1 m 5-wire 1.5 mm <sup>2</sup> , Wieland plug	3/N/PE ~ 400 (3N) V 50 Hz
4000 + 14	Black	MSET4.1 9005	4260409692701	IP65	400 x 9.5 x 12.5	9400	1 m 5-wire 1.5 mm <sup>2</sup> , Wieland plug	3/N/PE ~ 400 (3N) V 50 Hz
4000 + 14	Anthracite	MSET4.1 7016	4260409692725	IP65	400 x 9.5 x 12.5	9400	1 m 5-wire 1.5 mm <sup>2</sup> , Wieland plug	3/N/PE ~ 400 (3N) V 50 Hz



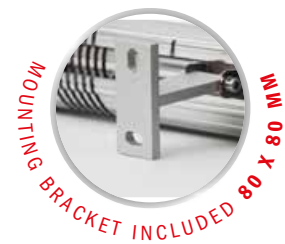

4 kW



400 cm

**MSET 4.2** = M2 + M1 + M1 + M2

2 x LED + 2 x Heater

IP65



POWER (in watt)	MATERIAL/ COLOR	CODE	EAN	IP PROTECTION CLASS	DIMENSIONS (W x H x D in cm)	WEIGHT (in g)	CABLE	CONNECTION
4000 + 14	White	MSET4.2 9010	4260409692732	IP65	400 x 9.5 x 12.5	9400	1 m 5-wire 1.5 mm <sup>2</sup> , Wieland plug	3/N/PE ~ 400 (3N) V 50 Hz
4000 + 14	Black	MSET4.2 9005	4260409692749	IP65	400 x 9.5 x 12.5	9400	1 m 5-wire 1.5 mm <sup>2</sup> , Wieland plug	3/N/PE ~ 400 (3N) V 50 Hz
4000 + 14	Anthracite	MSET4.2 7016	4260409692763	IP65	400 x 9.5 x 12.5	9400	1 m 5-wire 1.5 mm <sup>2</sup> , Wieland plug	3/N/PE ~ 400 (3N) V 50 Hz

MODULAR



4 kW

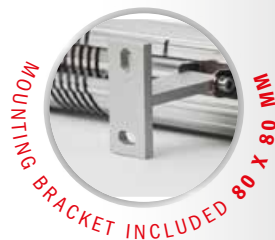

500 cm

**MSET 5.1** = M1 + M2 + M1 + M2 + M1

3 x LED + 2 x Heater



POWER (in watt)	MATERIAL/ COLOR	CODE	EAN	IP PROTECTION CLASS	DIMENSIONS (W x H x D in cm)	WEIGHT (in g)	CABLE	CONNECTION
4000 + 21	White	MSET5.1 9010	4260409692770	IP65	500 x 9.5 x 12.5	11800	1 m 5-wire 1.5 mm <sup>2</sup> , Wieland plug	3/N/PE ~ 400 (3N) V 50 Hz
4000 + 21	Black	MSET5.1 9005	4260409692787	IP65	500 x 9.5 x 12.5	11800	1 m 5-wire 1.5 mm <sup>2</sup> , Wieland plug	3/N/PE ~ 400 (3N) V 50 Hz
4000 + 21	Anthracite	MSET5.1 7016	4260409692800	IP65	500 x 9.5 x 12.5	11800	1 m 5-wire 1.5 mm <sup>2</sup> , Wieland plug	3/N/PE ~ 400 (3N) V 50 Hz

# INDIVIDUAL MODULES AND EQUIPMENT

## M 1



100 cm - 2 x 3.5 W LED

## M 2



100 cm - 1 x 2,000 W Heater

## M 3



100 cm - 2 x 3.5 W LED + 1 x 2,000 W Heater

## M PANEL



Available in 50 cm/75 cm/100 cm



POWER/DESCRIPTION	MATERIAL/COLOR	CODE	EAN	IP PROTECTION CLASS	DIMENSIONS (W x H x D in cm)	WEIGHT (in g)	CABLE	CONNECTION
<b>M1 LED MODULAR UNIT</b>								
2 x 3.5 watt	White	MRL2C9010	4260409691605	IP65	100 x 9.5 x 12.5	2000	1.9 m 3-wire 1.5 mm <sup>2</sup> , Schuko plug	1/N/PE ~ 230 V 50 Hz
2 x 3.5 watt	Black	MRL2C9005	4260409693098	IP65	100 x 9.5 x 12.5	2000	1.9 m 3-wire 1.5 mm <sup>2</sup> , Schuko plug	1/N/PE ~ 230 V 50 Hz
2 x 3.5 watt	Anthracite	MRL2C7016	4260409691629	IP65	100 x 9.5 x 12.5	2000	1.9 m 3-wire 1.5 mm <sup>2</sup> , Schuko plug	1/N/PE ~ 230 V 50 Hz
<b>M2 HEATER MODULAR UNIT</b>								
2000 watt	White	MURCAC200V9010	4260409691520	IP67	100 x 9.5 x 12.5	2300	1.9 m 3-wire 1.5 mm <sup>2</sup> , Schuko plug	1/N/PE ~ 230 V 50 Hz
2000 watt	Black	MURCAC200V9005	4260409693104	IP67	100 x 9.5 x 12.5	2300	1.9 m 3-wire 1.5 mm <sup>2</sup> , Schuko plug	1/N/PE ~ 230 V 50 Hz
2000 watt	Anthracite	MURCAC200V7016	4260409691513	IP67	100 x 9.5 x 12.5	2300	1.9 m 3-wire 1.5 mm <sup>2</sup> , Schuko plug	1/N/PE ~ 230 V 50 Hz
<b>M3 HEATER &amp; LED MODULAR UNIT</b>								
2000 + 7 watt	White	MURLHC21659010	4260409691551	IP65	100 x 9.5 x 12.5	2400	1 m 5-wire 1.5 mm <sup>2</sup> , Wire-end sleeves	1/N/PE ~ 230 V 50 Hz
2000 + 7 watt	Black	MURLHC21659005	4260409691544	IP65	100 x 9.5 x 12.5	2400	1 m 5-wire 1.5 mm <sup>2</sup> , Wire-end sleeves	1/N/PE ~ 230 V 50 Hz
2000 + 7 watt	Anthracite	MURLHC21657016	4260409691568	IP65	100 x 9.5 x 12.5	2400	1 m 5-wire 1.5 mm <sup>2</sup> , Wire-end sleeves	1/N/PE ~ 230 V 50 Hz
<b>PANELS</b>								
Panel 50 cm	White	M50BL9010	4260409693203	IP65	50 x 9.5 x 12.5	80		
Panel 50 cm	Black	M50BL9005	4260409693210	IP65	50 x 9.5 x 12.5	80		
Panel 50 cm	Anthracite	M50BL7016	4260409693227	IP65	50 x 9.5 x 12.5	80		
Panel 75 cm	White	M75BL9010	4260409693234	IP65	75 x 9.5 x 12.5	120		
Panel 75 cm	Black	M75BL9005	4260409693241	IP65	75 x 9.5 x 12.5	120		
Panel 75 cm	Anthracite	M75BL7016	4260409693258	IP65	75 x 9.5 x 12.5	120		
Panel 100 cm	White	M100BL9010	4260409693265	IP65	100 x 9.5 x 12.5	160		
Panel 100 cm	Black	M100BL9005	4260409693272	IP65	100 x 9.5 x 12.5	160		
Panel 100 cm	Anthracite	M100BL7016	4260409693289	IP65	100 x 9.5 x 12.5	160		



## MODULAR SIDEPART SET

With the modular sidepart sets you can easily connect every single Modules of Heat, Light, Nozzles, Panels or even TERM Color heaters within only seconds.

Standard Colors: 



SIDEPART

DESCRIPTION	MATERIAL/COLOR	CODE	EAN	DIMENSIONS (W x H x D in cm)	WEIGHT (in g)
SIDEPART SET	White	MSPS9010	4260409692213	1.0 x 9.5 x 8	140
SIDEPART SET	Black	MSPS9005	4260409692220	1.0 x 9.5 x 8	140
SIDEPART SET	Anthracite	MSPS7016	4260409692237	1.0 x 9.5 x 8	140

## NOZZLES

Our nozzle modules enable you to integrate our cooling function to every other module. The cooling works with our proven PERFECTCLIME technology.

Standard Colors: 



DESCRIPTION	MATERIAL/COLOR	CODE	EAN	DIMENSIONS (W x H x D in cm)	WEIGHT (in g)
MD1 Nozzle	White	MD19010	4260409692176	4.5 x 10 x 8	194
MD1 Nozzle	Black	MD19005	4260409692534	4.5 x 10 x 8	194
MD1 Nozzle	Anthracite	MD17016	4260409692619	4.5 x 10 x 8	194

## MODULAR FIXTURES

Standard Colors: 

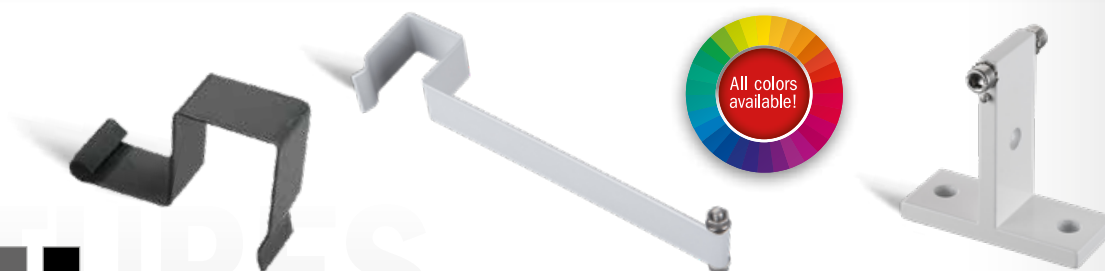

DESCRIPTION	MATERIAL/COLOR	CODE	EAN	DIMENSIONS (W x H x D in cm)	WEIGHT (in g)
Awning bracket, 4 cm	White	MB40409010	4260409692176	40 x 40 (B x T)	50
Awning bracket, 4 cm	Black	MB40409005	4260409692534	40 x 40 (B x T)	50
Awning bracket, 4 cm	Anthracite	MB40407016	4260409692619	40 x 40 (B x T)	50
Awning bracket, 20 cm	White	MB40402009010	4260409693432	40 x 40 x 200 (B x H x T)	55
Awning bracket, 20 cm	Black	MB40402009005	4260409693425	40 x 40 x 200 (B x H x T)	55
Awning bracket, 20 cm	Anthracite	MB40402007016	4260409693418	40 x 40 x 200 (B x H x T)	55
T-bracket	White	BCTF9010	4260409692961	8 (B)	50
T-bracket	Black	BCTF9005	4260409692978	8 (B)	50
T-bracket	Anthracite	BCTF7016	4260409692985	8 (B)	50

# The first **Heating** & **Cooling** Sensation!

**PATENTED**



## PERFECTCLIME®

OUTDOOR

The first heating & cooling concept combines infrared short-wave technology in one unit. Instant comfortable heat or refreshing cool air – resulting in a perfect temperature anytime and anywhere. Based on the successful TERM2000 IP67 and SMART IP24, instant heating is guaranteed and due to the integrated nozzle a fine haze leads to a comfortable atmosphere for nearly unlimited professional and private usage. PERFECTCLIME® only at Burda!

### APPLICATIONS

In all private, gastronomic, commercial, public or industrial outdoor areas



### Perfectclime® COOLING

Tailor-made misting and cooling systems for perfect humidity and refreshing coolness (see page 32).

**So simple and so effective!** The nebulized water, by means of a line of nozzles, lowers the temperature of the surrounding area by up to 12°C and evaporates as it falls to the ground, without wetting objects or people. PERFECTCLIME® Cooling Kit or the ready to go BASIC SET include high quality accessories and convinces with easy installation. The installation is simple and quick to perform and does not require the use of any specific tools.





70 cm

1.65 kW  
2 kW



With two nozzles



Mounting bracket included  
Aluminum-Color-Heater: **T-Bracket**  
Aluminum-Heater: **L-Bracket**

PERFECTCLIME® TERM2000 IP67 &  
PERFECTCLIME® TERM2000 COLOR IP67



POWER (in watt)	MATERIAL/COLOR	CODE	EAN	IP PROTECTION CLASS	DIMENSIONS (W x H x D in cm)	WEIGHT (in g)	CABLE	CONNECTION
1650	Silver	UPCRA165V2	4260051485669	IP67	70 x 9.5 x 12.5	2900	1.9 m 3-wire 1.5 mm², Schuko plug	1/N/PE ~ 230 V 50 Hz
2000	Silver	UPCRA200V2	4260051484488	IP67	70 x 9.5 x 12.5	2900	1.9 m 3-wire 1.5 mm², Schuko plug	1/N/PE ~ 230 V 50 Hz
1650	White	UPCRCAC165V29010	4260409691674	IP67	70 x 9.5 x 12.5	2900	1.9 m 3-wire 1.5 mm², Schuko plug	1/N/PE ~ 230 V 50 Hz
2000	White	UPCRCAC200V29010	4260409691681	IP67	70 x 9.5 x 12.5	2900	1.9 m 3-wire 1.5 mm², Schuko plug	1/N/PE ~ 230 V 50 Hz
1650	Black	UPCRCAC165V29005	4260409691698	IP67	70 x 9.5 x 12.5	2900	1.9 m 3-wire 1.5 mm², Schuko plug	1/N/PE ~ 230 V 50 Hz
2000	Black	UPCRCAC200V29005	4260409691704	IP67	70 x 9.5 x 12.5	2900	1.9 m 3-wire 1.5 mm², Schuko plug	1/N/PE ~ 230 V 50 Hz
1650	Anthracite	UPCRCAC165V27016	4260409691711	IP67	70 x 9.5 x 12.5	2900	1.9 m 3-wire 1.5 mm², Schuko plug	1/N/PE ~ 230 V 50 Hz
2000	Anthracite	UPCRCAC200V27016	4260409691728	IP67	70 x 9.5 x 12.5	2900	1.9 m 3-wire 1.5 mm², Schuko plug	1/N/PE ~ 230 V 50 Hz



1.65 kW + 7 W  
2 kW + 7 W  
4 kW + 14 W



87 cm

With two nozzles

91 cm

200 cm



PERFECTCLIME® TERM2000 L&H IP65



POWER (in watt)	MATERIAL/COLOR	CODE	EAN	IP PROTECTION CLASS	DIMENSIONS (W x H x D in cm)	WEIGHT (in g)	CABLE	CONNECTION
1650 + 7	Silver	UPCRLH1765F2	4260051484563	IP65	87 x 9.5 x 12.5	4050	2 m 5-wire 1.5 mm², Wire-end sleeves	2/N/PE ~ 230 V 50 Hz
2000 + 7	Silver	UPCRLH2165F2	4260051484594	IP65	87 x 9.5 x 12.5	4050	2 m 5-wire 1.5 mm², Wire-end sleeves	2/N/PE ~ 230 V 50 Hz
1650 + 7	Silver	UPCRLH17652	4260051484556	IP65	91 x 9.5 x 12.5	4050	2 m 5-wire 1.5 mm², Wire-end sleeves	2/N/PE ~ 230 V 50 Hz
2000 + 7	Silver	UPCRLH21652	4260051484570	IP65	91 x 9.5 x 12.5	4050	2 m 5-wire 1.5 mm², Wire-end sleeves	2/N/PE ~ 230 V 50 Hz
2 x 2000 + 14	Silver	UPCRLH42652	4260051484624	IP65	200 x 9.5 x 12.5	7700	2 m 5-wire 2.5 mm², Wire-end sleeves	3/N/PE ~ 400 V 50 Hz

PERFECTCLIME®

With one nozzle

- 3 kW
- 4 kW
- 6 kW
- 8 kW



## PERFECTCLIME® TERM TOWER PALMS IP67

Available and combinable with:

PERFECTCLIME®



waterproof

POWER (in watt)	MATERIAL/COLOR	CODE	EAN	IP PROTECTION CLASS	DIMENSIONS (W x H x D in cm)	WEIGHT (in g)	CABLE	CONNECTION
2 x 2000	Silver	UPCRTT400V	4260051484631	IP67	110 x 250-270	4900	10 m 5-wire 2.5 mm <sup>2</sup> , Wire-end sleeves	3/N/PE ~ 400 (3N) V 50 Hz
3 x 2000	Silver	UPCRTT600V	4260051484648	IP67	110 x 250-270	5100	10 m 5-wire 2.5 mm <sup>2</sup> , Wire-end sleeves	3/N/PE ~ 400 (3N) V 50 Hz
4 x 2000	Silver	UPCRTT800V	4260051484365	IP67	110 x 250-270	5270	10 m 5-wire 2.5 mm <sup>2</sup> , Wire-end sleeves	3/N/PE ~ 400 (3N) V 50 Hz
2 x 2000	Black	UPCRTT400V9005	4260409691797	IP67	110 x 250-270	4900	10 m 5-wire 2.5 mm <sup>2</sup> , Wire-end sleeves	3/N/PE ~ 400 (3N) V 50 Hz
3 x 2000	Black	UPCRTT600V9005	4260409691803	IP67	110 x 250-270	5100	10 m 5-wire 2.5 mm <sup>2</sup> , Wire-end sleeves	3/N/PE ~ 400 (3N) V 50 Hz
4 x 2000	Black	UPCRTT800V9005	4260409691810	IP67	110 x 250-270	5270	10 m 5-wire 2.5 mm <sup>2</sup> , Wire-end sleeves	3/N/PE ~ 400 (3N) V 50 Hz
2 x 2000	White	UPCRTT400V9010	4260409691827	IP67	110 x 250-270	4900	10 m 5-wire 2.5 mm <sup>2</sup> , Wire-end sleeves	3/N/PE ~ 400 (3N) V 50 Hz
3 x 2000	White	UPCRTT600V9010	4260409691834	IP67	110 x 250-270	5100	10 m 5-wire 2.5 mm <sup>2</sup> , Wire-end sleeves	3/N/PE ~ 400 (3N) V 50 Hz
4 x 2000	White	UPCRTT800V9010	4260409691841	IP67	110 x 250-270	5270	10 m 5-wire 2.5 mm <sup>2</sup> , Wire-end sleeves	3/N/PE ~ 400 (3N) V 50 Hz



- 1.5 kW
- 2 kW
- 3 kW
- 4 kW
- 6 kW

With two nozzles

63 cm

111.5 cm

151.5 cm



(UL1278/UL2021)



Mounting bracket included (L-Bracket)



MULTIBRACKET INCLUDED

## PERFECTCLIME® SMART IP24

LOW GLARE

POWER (in watt)	MATERIAL/COLOR	CODE	EAN	IP PROTECTION CLASS	DIMENSIONS (W x H x D in cm)	WEIGHT (in g)	CABLE	CONNECTION
1500	White	PCBHS15242	4260051486536	IP24	63 x 14.5 x 9.5	2500	1.9 m 3-wire 1.5 mm <sup>2</sup> , Schuko plug	1/N/PE ~ 230 V 50 Hz
2000	White	PCBHS20242	4260051486543	IP24	63 x 14.5 x 9.5	2500	1.9 m 3-wire 1.5 mm <sup>2</sup> , Schuko plug	1/N/PE ~ 230 V 50 Hz
2 x 1500	White	PCBHS30242	4260051485065	IP24	111.5 x 14.5 x 9.5	4000	1.9 m 3-wire 1.5 mm <sup>2</sup> , Schuko plug	1/N/PE ~ 230 V 50 Hz
2 x 2000	White	PCBHS40242	4260051485089	IP24	111.5 x 14.5 x 9.5	4000	0.65 m 5-wire 2.5 mm <sup>2</sup> , Wire-end sleeves	2/N/PE ~ 230 V 50 Hz
3 x 2000	White	PCBHS60242	4260051485102	IP24	151.5 x 14.5 x 9.5	6000	0.65 m 5-wire 2.5 mm <sup>2</sup> , Wire-end sleeves	3/N/PE ~ 400 V (3N) 50 Hz



## PERFECTCLIME® PUMP



DESCRIPTION	CODE	EAN	PRESSURE	CONSUMPTION
Pump 05	PCE05	4260051482347	70 bar	0.5 l/m
Pump 1	PCE1	4260051482354	70 bar	0.9 l/m

## PERFECTCLIME® COUPLINGS

PICTURE	DESCRIPTION	CODE	EAN
	T-Coupling	PCKT	4260051483245
	L-Coupling	PCKL	4260051483252
	Straight Coupling	PCKS	4260051483856
	End Coupling	PCKE	4260051483269
	Angle Coupling	PCKG	4260051483276
	Connection coupling, nickel-plated brass, 1/4" NPT M - ø6,35mm - 1/4"	PCIT.0330	4260409695948

## PERFECTCLIME® POLYAMIDE PIPELINE

ABBILDUNG	DESCRIPTION	CODE	EAN
	Polyamid Pipeline 25 cm	PCPS25	4260051483290
	Polyamid Pipeline 75 cm Gerte	PCPG7	4260051483313
	Polyamid Cutter	PCPC	4260051483320
	Polyamid pipe mounting	PCPB	4260051483337
	Stainless steel Pipeline, 100 cm, ø6,35 mm	PCSS100	4260409695306
	Stainless steel Pipeline, 75 cm, ø6,35 mm	PCSS75	4260409695313
	Stainless steel Pipeline, 30 cm, ø6,35 mm	PCSS30	4260409695320

## PERFECTCLIME® NOZZLES



DESCRIPTION	CODE	EAN	56 BAR VERSION	70 BAR VERSION	84 BAR VERSION
Nozzle 0.15 mm	PCN15	4260051483207	0.041 l/min 0.011 US Gpm	0.046 l/min 0.0095 US Gpm	0.051 l/min 0.012 US Gpm
Nozzle 0.2 mm	PCN20	4260051483214	0.080 l/min 0.021 US Gpm	0.089 l/min 0.024 US Gpm	0.098 l/min 0.026 US Gpm
Nozzle 0.3 mm	PCN30	4260051483221	0.130 l/min 0.034 US Gpm	0.145 l/min 0.038 US Gpm	0.159 l/min 0.042 US Gpm
Nozzle 0.4 mm	PCN40	4260051483238	0.159 l/min 0.047 US Gpm	0.178 l/min 0.047 US Gpm	0.195 l/min 0.052 US Gpm

## PERFECTCLIME® FILTER



DESCRIPTION	CODE	EAN
Filter clause chalk	PCFKUEU	4260051483344
Particle filter	PCFS	4260051483351
Particle filter Mini	PCFSM	4260409695955

## PERFECTCLIME® UV FILTER



CODE	EAN	CAPACITY	PRESSURE
PCFUV4	4260051482880	480 l/h	6 Bar
PCFUV5	4260051482897	500 l/h	7-10 Bar



# PERFECTCLIME® COOLING KIT

Construction kit for tailor-made misting and cooling systems for perfect humidity and refreshing coolness.

**So simple and so effective!** The nebulized water, by means of a line of nozzles, lowers the temperature of the surrounding area by up to 12°C and evaporates as it falls to the ground, without wetting objects or people. PERFECTCLIME® Cooling Kit includes high quality accessories and convinces with easy installation. All parts are either made of AISI 304 stainless steel or nickel-plated brass. The installation is simple, quick to perform and does not require the use of any specific tools.



ABBILDUNG	BEZEICHNUNG	CODE	EAN
	Stainless steel Pipeline, 100 cm, ø6,35 mm	PCSS100	4260409695306
	Stainless steel Pipeline, 75 cm, ø6,35 mm	PCSS75	4260409695313
	Stainless steel Pipeline, 30 cm, ø6,35 mm	PCSS30	4260409695320
	Polyamid Pipeline, 25 cm, 6,35 mm, Black	PCPS25	4260051483290
	Polyamid Pipeline, 25 m, 6,35 mm, White	PCPS25-2	4260409695245
	Nozzle 0,3 mm	PCN30	4260051483221
	Nozzle 0,2 mm	PCN20	4260051483214
	Nozzle 0,15 mm	PCN15	4260051483207
	Nozzle Coupling, End	PCKDE	4260409695337
	Nozzle Coupling, Straight	PCKDM	4260409695344
	Connection coupling, nickel-plated brass, 1/4" NPT M - ø6,35mm - 1/4"	PCIT.0330	4260409695948
	Straight Coupling 6,35 mm	PCKS	4260051483856
	End Coupling 6,35 mm	PCKE	4260051483269
	T-Coupling 6,35 mm	PCKT	4260051483245
	L-Coupling 6,35 mm	PCKL	4260051483252
	Polyamid pipe mounting, ø6,35 mm	PCPB	4260051483337
	Polyamid cutter	PCPC	4260051483320
<b>ADD ON MISTING</b>			
	Pump 0,5	PCE05	4260051482347
	Pump 1 l	PCE1	4260051482354
	Particle filter	PCFS	4260051483351
	Particle filter Mini	PCFSM	4260409695955
<b>ADD ON MISTING OPTIONAL</b>			
	Filter clause chalk	PCFKUEU	4260051483344
	UV filter, 480 l/hr	PCFUV4	4260051482880
	UV filter, 500 l/hr	PCFUV5	4260051482897

## PERFECTCLIME® COOLING BASIC SET

PC COOLING set in three meters total length, straight, including four nozzles. Easy installation without special tools.



BEZEICHNUNG	CODE	EAN
PERFECTCLIME® COOLING BASIC SET	PCBASIC300	4260409695733

**IM BASIC SET ENTHALTEN:** ✓3 x PCSS100 Stainless steel pipe, ø6,35 mm ✓3 x PCKDM Nozzle Coupling, Straight ✓1 x PCKDE Nozzle Coupling, End ✓4 x PCN20 Nozzle ✓1 x PCKL L-Coupling 6,35 mm, Hose guide from pipeline to pump ✓1 x PCPS25 Polyamid pipe, black, ø6,35 mm ✓6 x PCPB Polyamid pipe mounting ø6,35 mm ✓1 x PCPC Polyamid cutter ✓1 x PCE05 Pump 0,5 l ✓1 x PCFS Particle filter ✓1 x PCIT.0330 Connection coupling, nickel-plated brass, 1/4" NPT M - ø6,35 mm - 1/4"





# CONTROL

CONTROL

Tailored to our infrared heating and lighting range, our accessories provide intelligent solutions for the use and operation of our systems. Dimmers, timers and remote control solutions enable optimized, customized heat management – simple and effective.

## REMOTE DIMMERS



## BLUETOOTH DIMMER IP65

BLUETOOTH DIMMER for smart control of up to two heaters with a maximum overall performance of 3000 watt. Including FREE remote control as well as FREE BURDA APP for all iOS and Android devices.

Slow blow fuse 16 amp (C16) recommended



POWER/ DESCRIPTION	MATERIAL/ COLOR	CODE	EAN	IP PROTECTION CLASS	DIMENSIONS (W x H x D in cm)	WEIGHT (in g)	CABLE	CONNECTION
<b>REMOTE SOFTSTART DIMMER</b>								
250 watt	Dimmer 50/66/100 %	BRFE025	4260051489285	IP54	10 x 4 x 1.6	300	Supply pipe 3 m, connection heater 90 cm, wire-end sleeves both sides	1/N/PE ~ 230 V 50 Hz
2000 watt	Dimmer 50/66/100 %	BRFE20	4260051489261	IP54	14.5 x 4.8 x 2.9	360	Power cable 490 mm (STAS 3), cable to heater 235 mm (STAK 3)	1/N/PE ~ 230 V 50 Hz
<b>REMOTE CONTROL</b>								
BIDirectional Solo 1 Channel	Black	BRD_S1	4260051489209	IP20	7.4 x 4.4 x 1.5	120		
BIDirectional Solo 1 Channel	White	BRD_S2	4260051489216	IP20	7.4 x 4.4 x 1.5	120		
BIDirectional Solo 1 Channel	Silver	BRD_S3	4260051489223	IP20	7.4 x 4.4 x 1.5	120		
BIDirectional Mono 1 Channel	Silver	BRD-BM3	4260051483801	IP20	5.1 x 12 x 2.6	120		
BIDirectional Mono 1 Channel	White	BRD-BM2	4260051483818	IP20	5.1 x 12 x 2.6	120		
BIDirectional Mono 1 Channel	Anthracite	BRD-BM5	4260051484204	IP20	5.1 x 12 x 2.6	120		
BIDirectional Vario 5 Channel	White	BRD-BV2	4260051483825	IP20	5.1 x 12 x 2.6	120		
BIDirectional Vario 5 Channel	Silver	BRD-BV3	4260051483832	IP20	5.1 x 12 x 2.6	120		
BIDirectional Vario 5 Channel	Anthracite	BRD-BV5	4260051484211	IP20	5.1 x 12 x 2.6	120		



# DIMMER/TIMER



4 kW  
6 kW  
1 Channel

BHC 4001/BHC 6001



6 kW  
3 Channels

4 kW  
2 Channels

BHC 4002/BHC 6003  
9 channel bus system



2 kW  
4 kW  
6 kW  
1 Channel

Timer TS2/TS4/TS6

MATERIAL/ COLOR	POWER/ DESCRIPTION	CODE	EAN	IP PROTECTION CLASS	DIMENSIONS (W x H x D in cm)	WEIGHT (in g)	CABLE	CONNECTION
<b>BLUETOOTH DIMMER IP65</b>								
3000, 1 Zone	Aluminum	BTD3	4260409691094	IP65	11.8 x 8.8 x 4.8	900	2 x 1.9 m 3-wire 1.5 mm <sup>2</sup> , Schuko plug and socket	1/N/PE ~ 230 V 50 Hz
<b>BLUETOOTH REMOTE CONTROL</b>								
	White	BTR	4260409692510	IP20	11.8 x 4 x 1.5	60		
<b>BH CONTROLLER 1 ZONE IP65 FIXED CONNECTION</b>								
Dimmer, 10-stage	4000 watt, 1 Zone	BHC4001	4260051480169	IP65	28 x 17 x 8.7	2150		1/N/PE ~ 230 V 50 Hz
Dimmer, 10-stage	6000 watt, 1 Zone	BHC6001	4260051481562	IP65	28 x 17 x 8.7	2150		1/N/PE ~ 230 V 50 Hz
Dimmer, 10-stage	Remote control 1	BHCR1	4260051480176	IP20	4.5 x 26 x 2	80		
<b>BH CONTROLLER 9 ZONE IP65 FIXED CONNECTION</b>								
Dimmer, 10-stage	4000 watt, 2 Zones	BHC4002-ER	4260051482835	IP65	28 x 17 x 8.7	2150		1/N/PE ~ 230 V 50 Hz
Dimmer, 10-stage	6000 watt, 3 Zones	BHC6003-ER	4260051482842	IP65	28 x 17 x 8.7	2150		3/N/PE ~ 400 V 50 Hz
Dimmer, 10-stage	4000 watt, 2 Zones	BHC4002D	4260051483443	IP65	28 x 17 x 8.7	2150		1/N/PE ~ 230 V 50 Hz
Dimmer, 10-stage	6000 watt, 3 Zones	BHC6003D	4260051483450	IP65	28 x 17 x 8.7	2150		3/N/PE ~ 400 V 50 Hz
Dimmer, 10-stage	Keypad	BHCK	4260051483559	IP65	12 x 9 x 4	220		
Dimmer, 10-stage	Remote control 9	BHCR9	4260051483306	IP20	4.5 x 26 x 2	80		
<b>TIMER SOFTSTART</b>								
	2000 watt	TS2-C	4260051480107	IP20	9.5 x 13 x 5.5	475	1.5 m 3-wire 1.5 mm <sup>2</sup> PVC; with Schuko plug 0.5 m 3-wire 1.5 mm <sup>2</sup> PVC, with socket	1/N/PE ~ 230 V 50 Hz
	4000 watt	TS4	4260051480077	IP65	10 x 12.5 x 7	475	Fixed connection	1/N/PE ~ 230 V 50 Hz
	6000 watt	TS6	4260409691254	IP65	13 x 13 x 7	475	Fixed connection	1/N/PE ~ 230 V 50 Hz

# MOTION DETECTORS/TEMPERATURE SENSORS



BPIR



BPIR4

4 kW



BPIR6

6 kW

CONTROL

POWER/ DE- SCRIPTION	COLOR	CODE	EAN	IP PROTECTION CLASS	DIMENSIONS (W x H x D in cm)	WEIGHT (in g)	CABLE	CONNECTION
<b>MOTION DETECTOR WITH TEMPERATURE SENSOR</b>								
BPIR	White	BPIR	4260051485942	IP65	10 x 8 x 11.7	140	Fixed connection	1/N/PE ~ 230 V 50 Hz
BPIR4, 4000 watt	White	BPIR4	4260051485959	IP65	10 x 10 x 6	280	Fixed connection	1/N/PE ~ 230 V 50 Hz
BPIR6, 6000 watt	White	BPIR6	4260051485966	IP65	13 x 13 x 7.5	600	Fixed connection	1/N/PE ~ 230 V 50 Hz





## ADD-ON

Are you looking for a way to install our systems temporarily and to quickly assemble and dismantle them? Our range of clamping and stand solutions are just what you're looking for – stability and rapid assembly guaranteed.



Standard with every Color and No Glare heater



T-BRACKET

The T-bracket serves as wall mounting for all TERM2000 COLOR models. Instead of a T-bracket you can mount the Color and No Glare heaters with our two other brackets **MB040** and the **Short bracket** (available as add-on).

SHORT BRACKET



It functions on Color and No Glare heaters in combination with our ceiling bracket **BCDF20** as a adapter for a stable mounting (available in white, black and anthracite)

Standard with every aluminum heater



L-BRACKET



CEILING BRACKET



Ceiling mounting **BCDF20** for Color, No Glare and aluminum heaters (available in white, black, anthracite and aluminum), 20 cm

DESCRIPTION	CODE	EAN	DIMENSIONS (Length in cm)	WEIGHT (in g)
<b>CEILING BRACKET</b>				
Ceiling fixture, Silver	BCDF20	4260409691452	20	50
Ceiling fixture, White	BCDF209010	4260409691469	20	50
Ceiling fixture, Black	BCDF209005	4260409691476	20	50
Ceiling fixture, Anthracite	BCDF207016	4260409691483	20	50
<b>L-BRACKET</b>				
L-Bracket, Silver	BCLF	4260409693494	13	50
<b>SHORT BRACKET</b>				
Short bracket, Silver	BCSF	4260409693715	2.5	50
Short bracket, White	BCSF9010	4260409693463	2.5	50
Short bracket, Black	BCSF9005	4260409693470	2.5	50
Short bracket, Anthracite	BCSF7016	4260409693487	2.5	50
<b>T-BRACKET</b>				
T-Bracket, White	BCTF9010	4260409692961	8	50
T-Bracket, Black	BCTF9005	4260409692978	8	50
T-Bracket, Anthracite	BCTF7016	4260409692985	8	50

POLE BRACKET



Strut and mast bracket with Velcro

TRIPOD STAND



Stand up to 210 cm



HIRSCHMANN SET

DESCRIPTION	CODE	EAN
<b>CLAMPS</b>		
Strut bracket, 1 heater, Silver	KLS1KS	4260051489186
<b>STANDS</b>		
STATIV, White	BHSS-2	4260051487144
STATIV, Silver	BHSS-3	4260051487151
STATIV, Black	BHSS-1	4260051481357
<b>HIRSCHMANN SET</b>		
BRHS	STAS 3 + STAK 3 + Stasi	4260051489094

# LAMPS

Spare tubes for TERM2000 and SMART infrared heaters

DESCRIPTION	POWER (in watt)	CODE	EAN	IP PROTECTION CLASS	DIMENSIONS (Length in cm)	WEIGHT (in g)	CABLE	CONNECTION
<b>LAMPS TERM2000 IP20/IP24/IP44</b>								
IP20 Cable 357.5 mm	1000	LG1000	4260051486017	IP20	35.75	50	295 mm double-sided, Wire-end sleeves	1/N/PE ~ 230 V 50 Hz
IP20 Cable 357.5 mm	1000	LG1000V	4260051486048	IP20	35.75	50	295 mm double-sided, Wire-end sleeves	1/N/PE ~ 230 V 50 Hz
IP20 Cable 357.5 mm	1500	LG1500	4260051486024	IP20	35.75	50	295 mm double-sided, Wire-end sleeves	1/N/PE ~ 230 V 50 Hz
IP20 Cable 357.5 mm	1500	LG1500V	4260051486000	IP20	35.75	50	295 mm double-sided, Wire-end sleeves	1/N/PE ~ 230 V 50 Hz
IP20 Cable 357.5 mm	2000	LG2000	4260051486031	IP20	35.75	50	295 mm double-sided, Wire-end sleeves	1/N/PE ~ 230 V 50 Hz
IP20 Cable 357.5mm	2000	LG2000V	4260051486055	IP20	35.75	50	295 mm double-sided, Wire-end sleeves	1/N/PE ~ 230 V 50 Hz
IP24 Cable 355 mm	1000	LG1024	4260051486123	IP24	35.5	50	235 mm and 590 mm, Wire-end sleeves	1/N/PE ~ 230 V 50 Hz
IP24 Cable 355 mm	1500	LG1524	4260051486130	IP24	35.5	50	295 mm double-sided, Wire-end sleeves	1/N/PE ~ 230 V 50 Hz
IP24 Cable 355 mm	2000	LG2024	4260051486147	IP24	35.5	50	235 mm and 590 mm, Wire-end sleeves	1/N/PE ~ 230 V 50 Hz
IP24 Cable 355 mm	1000	ULGS1024V	4260051485454	IP24	35.5	50	235 mm and 590 mm, Wire-end sleeves	1/N/PE ~ 230 V 50 Hz
IP24 Cable 355 mm	1500	ULGS1524V	4260051484129	IP24	35.5	50	235 mm and 590 mm, Wire-end sleeves	1/N/PE ~ 230 V 50 Hz
IP24 Cable 355 mm	2000	ULGS2024V	4260051484136	IP24	35.5	50	235 mm and 590 mm, Wire-end sleeves	1/N/PE ~ 230 V 50 Hz
<b>LAMPS TERM2000 IP65/IP67</b>								
IP65/67 Cable 380 mm	1000	LG1001	4260051486185	IP65/67	38	50	300 mm and 920 mm, Wire-end sleeves	1/N/PE ~ 230 V 50 Hz
IP65/67 Cable 380 mm	1700	LGS1700V	4260051485973	IP65/67	38	50	300 mm and 920 mm, Wire-end sleeves	1/N/PE ~ 230 V 50 Hz
IP65/67 Cable 529 mm	1650	LG1650	4260051486093	IP65/67	52.9	50	300 mm and 920 mm, Wire-end sleeves	1/N/PE ~ 230 V 50 Hz
IP65/67 Cable 529 mm	2000	LG2001V	4260051486109	IP65/67	52.9	50	300 mm and 920 mm, Wire-end sleeves	1/N/PE ~ 230 V 50 Hz
IP65/67 Cable 380 mm	1000	ULG1001V	4260051485508	IP65/67	38	50	300 mm and 920 mm, Wire-end sleeves	1/N/PE ~ 230 V 50 Hz
IP65/67 Cable 529 mm	1500	ULG1500V	4260051485430	IP65/67	52.9	50	300 mm and 920 mm, Wire-end sleeves	1/N/PE ~ 230 V 50 Hz
IP65/67 Cable 529 mm	1650	ULG1650V	4260051484105	IP65/67	52.9	50	300 mm and 920 mm, Wire-end sleeves	1/N/PE ~ 230 V 50 Hz
IP65/67 Cable 529 mm	2000	ULG2001V	4260051484112	IP65/67	52.9	50	300 mm and 920 mm, Wire-end sleeves	1/N/PE ~ 230 V 50 Hz
<b>LAMPS BH SMART R7S IP20</b>								
R7S Push-In 254 mm	800	LGHR800V	4260051488189	IP20	25.4	50		230 V 50 Hz
R7S Push-In 254 mm	1000	LGHR1000V	4260051488035	IP20	25.4	50		230 V 50 Hz
R7S Push-In 254 mm	1300	LGHR1300V	4260051488073	IP20	25.4	50		230 V 50 Hz
<b>LAMPS BH SMART SK15 IP20/IP24</b>								
IP20 Cable 350 mm	1500	LGHS1500V	4260051484877	IP20		50	300 mm double-sided, Wire-end sleeves	1/N/PE ~ 230 V 50 Hz
IP20 Cable 350 mm	2000	LGHS2000	4260051488103	IP20		50	300 mm double-sided, Wire-end sleeves	1/N/PE ~ 230 V 50 Hz
IP24 Cable 350 mm	1500	LGHS1524V	4260051480770	IP24		50	590 mm and 240 mm, Wire-end sleeves	1/N/PE ~ 230 V 50 Hz
IP24 Cable 350 mm	2000	LGHS2024	4260051489605	IP24		50	590 mm and 240 mm, Wire-end sleeves	1/N/PE ~ 230 V 50 Hz
<b>LAMPS RELAX GLASS IRA IP65</b>								
RELAX GLASS Tube	1200	BRELGR1200	4260409695559			50 g/pc		
RELAX GLASS Tube	1500	BRELGR1500	4260409695542			70 g/pc		
RELAX GLASS Tube	1800	BRELGR1800	4260409695535			70 g/pc		
RELAX GLASS Tube	2200	BRELGR2200	4260409695528			70 g/pc		

Panel heaters from Burda –

# COSY WARMTH

like from a tiled stove

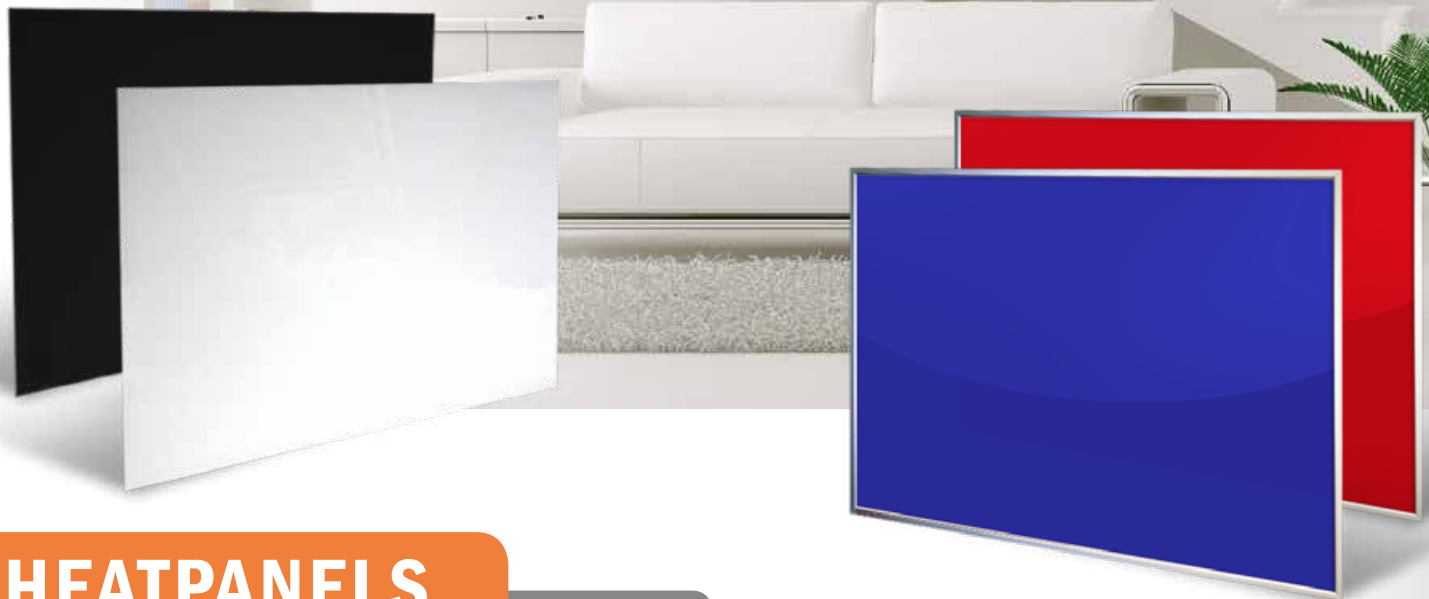

## HEATPANELS

INDOOR

BURDA heatpanels function like the sun: They emit infrared beams which create warmth and work as heat accumulators when they hit people and objects. The energy-consuming „detour“ of convection heating of air in conventional rooms is no longer required. This makes Burda heatpanels economical and your heating experience refreshingly relaxing. Enjoy Burda heatpanels like the sun's rays on a clear winter's day!

### APPLICATIONS

Bathroom, waiting rooms, medical practice, hotels, office and home

### EU Ecodesign 2015/1188

The installation and use of the heatpanels from 1.1.2018 is only permitted in connection with external thermostats which fulfill the following functions:

- Electronic room temperature control and weekday control
- Adaptive heating control

These requirements are met i. e. with our thermostats: BHC1868, BHCINSTAT+3R, BHCFT3R  
Failure to comply with these requirements will result in the loss of the CE mark





## BASIC HEAT IP54

### FRAMELESS WALL HEATER

The wall heater BASIC HEAT is our cost-effective universal solution. The 500 watt heating plate in white is certified with protection class IP54 (splash water proof) and thus also suitable for use in damp areas. A toggle switch on the device allows convenient on/off switching. Please note: the heating panel is not suitable for ceiling mounting!

- ✓ Painted smooth white
- ✓ Frameless
- ✓ ON-/OFF switch
- ✓ 1.5 cm deep
- ✓ Protection Class IP54, waterproof
- ✓ Heat dissipation at almost 100 % on the front
- ✓ Comes with wall-mounting kit
- ✓ Includes 1.9 m cable and plug
- ✓ 5-year guarantee

CODE	EAN	SURFACE	MEASUREMENT (length in cm)	PERFORMANCE (in watt)	IP PROTECTION CLASS	WEIGHT (in kg)	CONNECTION
BHPBH50100500	4260409694712	White smooth	50 x 100 x 1.5	500	IP54	10	1/N/PE ~ 230 V 50 Hz



## CLASSIC HEAT IP20

### FRAMELESS WALL AND CEILING HEATER

Our standard model with optimal heating performance. Robust aluminum/steel housing 1.6 cm thick.

The CLASSIC HEAT guarantees particularly high heat dissipation through its specially coated surface. The heat panel is scratch resistant and non-yellowing. Suitable for wall and ceiling mounting.

- ✓ Painted smooth white
- ✓ Frameless
- ✓ 1.6 cm deep
- ✓ Heat dissipation at almost 100 % on the front
- ✓ Safety shut-down in case of overheating
- ✓ Comes with wall- or ceiling mounting kit
- ✓ Includes 1.9 m cable and plug
- ✓ Protection Class IP20
- ✓ 5-year guarantee

CODE	EAN	SURFACE	MEASUREMENT (length in cm)	PERFORMANCE (in watt)	IP PROTECTION CLASS	WEIGHT (in kg)	CONNECTION
BHPCLH4060300	4260409694514	White smooth	60 x 40 x 1.6	300	IP20	4	1/N/PE ~ 230 V 50 Hz
BHPCLH6262400	4260409694347	White smooth	62 x 62 x 1.6	400	IP20	4	1/N/PE ~ 230 V 50 Hz
BHPCLH6060400	4260409694354	White smooth	60 x 60 x 1.6	400	IP20	4	1/N/PE ~ 230 V 50 Hz
BHPCLH6090600	4260409694361	White smooth	60 x 90 x 1.6	600	IP20	8	1/N/PE ~ 230 V 50 Hz
BHPCLH60120900	4260409694378	White smooth	60 x 120 x 1.6	900	IP20	9	1/N/PE ~ 230 V 50 Hz



## GLASS HEAT RAL IP44 WITH ALUMINUM FRAME / FRAMELESS



COLORED GLASS HEAT PANEL WITH FRAME OR FRAMELESS IN ANY DESIRED RAL COLOR.

Very stylish and elegant-looking infrared heat panel with a surface made of high-gloss, heat-resistant, special-purpose glass.

- ✓ Special glass in an aluminum case
- ✓ aluminum frame, 15 mm or frameless
- ✓ 2.5 cm deep
- ✓ Choose from a wide range of RAL-Colors
- ✓ Protection Class IP44
- ✓ Heat dissipation at almost 100 % on the front
- ✓ Safety shut-down in case of overheating
- ✓ Comes with wall-mounting kit
- ✓ Includes 1.9 m cable and plug
- ✓ 5-year guarantee

CODE	EAN	SURFACE	MEASUREMENT (length in cm)	PERFORMANCE (in watt)	IP PROTECTION CLASS	WEIGHT (in kg)	CONNECTION
BHPGHR6070400	4260409690288	Glass RAL	60 x 70 x 2.5	400	IP44	8	1/N/PE ~ 230 V 50 Hz
BHPGHR6090500	4260409690295	Glass RAL	60 x 90 x 2.5	500	IP44	11	1/N/PE ~ 230 V 50 Hz
BHPGHR60120700	4260409690318	Glass RAL	60 x 120 x 2.5	700	IP44	14	1/N/PE ~ 230 V 50 Hz
BHPGHR60140900	4260409690325	Glass RAL	60 x 140 x 2.5	900	IP44	16	1/N/PE ~ 230 V 50 Hz
FRAMELESS							
BHPGHRF6070400	4260409690332	Glass RAL	60 x 70 x 2.5	400	IP44	8	1/N/PE ~ 230 V 50 Hz
BHPGHRF6090500	4260409690349	Glass RAL	60 x 90 x 2.5	500	IP44	11	1/N/PE ~ 230 V 50 Hz
BHPGHRF60120700	4260409690363	Glass RAL	60 x 120 x 2.5	700	IP44	14	1/N/PE ~ 230 V 50 Hz
BHPGHRF60140900	4260409690370	Glass RAL	60 x 140 x 2.5	900	IP44	16	1/N/PE ~ 230 V 50 Hz



## GLASS HEAT IP44 WITH ALUMINUM FRAME



COLORED GLASS HEAT PANEL WITH FRAME

Very stylish and elegant-looking infrared heat panel with a surface made of high-gloss, heat-resistant, special-purpose glass.

- ✓ Special glass in an aluminum case
- ✓ Aluminium frame, 15 mm
- ✓ 2.5 cm deep
- ✓ Black or white surface
- ✓ Protection Class IP44
- ✓ Heat dissipation at almost 100 % on the front
- ✓ Safety shut-down in case of overheating
- ✓ Comes with wall-mounting kit
- ✓ Includes 1.9 m cable and plug
- ✓ 5-year guarantee

CODE	EAN	SURFACE	MEASUREMENT (length in cm)	PERFORMANCE (in watt)	IP PROTECTION CLASS	WEIGHT (in kg)	CONNECTION
BHPGH6070400w	4260409690011	Glass White	60 x 70 x 2.5	400	IP44	8	1/N/PE ~ 230 V 50 Hz
BHPGH6090500w	4260051489193	Glass White	60 x 90 x 2.5	500	IP44	11	1/N/PE ~ 230 V 50 Hz
BHPGH60120700w	4260051489780	Glass White	60 x 120 x 2.5	700	IP44	14	1/N/PE ~ 230 V 50 Hz
BHPGH60140900w	4260409690066	Glass White	60 x 140 x 2.5	900	IP44	16	1/N/PE ~ 230 V 50 Hz
BHPGH6070400sw	4260409690097	Glass Black	60 x 70 x 2.5	400	IP44	8	1/N/PE ~ 230 V 50 Hz
BHPGH6090500sw	4260051489797	Glass Black	60 x 90 x 2.5	500	IP44	11	1/N/PE ~ 230 V 50 Hz
BHPGH60120700sw	4260051489803	Glass Black	60 x 120 x 2.5	700	IP44	14	1/N/PE ~ 230 V 50 Hz
BHPGH60140900sw	4260409690141	Glass Black	60 x 140 x 2.5	900	IP44	16	1/N/PE ~ 230 V 50 Hz





## GLASS HEAT FRAMELESS IP44



COLORED GLASS HEAT PANEL WITHOUT FRAME

Very stylish and elegant-looking infrared heat panel with a surface made of high-gloss, heat-resistant, white special-purpose glass.

- ✓ Special glass in an aluminum case
- ✓ Frameless
- ✓ 2.5 cm deep
- ✓ Black or white surface
- ✓ Protection Class IP44
- ✓ Heat dissipation at almost 100 % on the front
- ✓ Safety shut-down in case of overheating
- ✓ Comes with wall-mounting kit
- ✓ Includes 1.9 m cable and plug
- ✓ 5-year guarantee

CODE	EAN	SURFACE	MEASUREMENT (length in cm)	PERFORMANCE (in watt)	IP PROTECTION CLASS	WEIGHT (in kg)	CONNECTION
BHPGHF6070400w	4260409690165	Glass White	60 x 70 x 2.5	400	IP44	8	1/N/PE ~ 230 V 50 Hz
BHPGHF6090500w	4260051488974	Glass White	60 x 90 x 2.5	500	IP44	11	1/N/PE ~ 230 V 50 Hz
BHPGHF60120700w	4260051488981	Glass White	60 x 120 x 2.5	700	IP44	14	1/N/PE ~ 230 V 50 Hz
BHPGHF60140900w	4260409690219	Glass White	60 x 140 x 2.5	900	IP44	16	1/N/PE ~ 230 V 50 Hz
BHPGHF6070400sw	4260409690226	Glass Black	60 x 70 x 2.5	400	IP44	8	1/N/PE ~ 230 V 50 Hz
BHPGHF6090500sw	4260051488998	Glass Black	60 x 90 x 2.5	500	IP44	11	1/N/PE ~ 230 V 50 Hz
BHPGHF60120700sw	4260051489001	Glass Black	60 x 120 x 2.5	700	IP44	14	1/N/PE ~ 230 V 50 Hz
BHPGHF60140900sw	4260409690271	Glass Black	60 x 140 x 2.5	900	IP44	16	1/N/PE ~ 230 V 50 Hz



## IMAGE GLASS HEAT IP44 WITH ALUMINUM FRAME

FRAMED GLASS HEAT PANEL WITH MOTIF



Highly elegant and stylish heat panel with a high gloss, heat-resistant image glass surface. You can choose from a wide range of images available in our database at [www.burdawtg.de/motive](http://www.burdawtg.de/motive), or opt for a custom image for an additional fee!

- ✓ Special glass in an aluminum case
- ✓ aluminium frame, 15 mm
- ✓ 2.5 cm deep
- ✓ With motif of your choice
- ✓ Protection Class IP44
- ✓ Heat dissipation at almost 100 % on the front
- ✓ Safety shut-down in case of overheating
- ✓ Comes with wall-mounting kit
- ✓ Includes 1.9 m cable and plug
- ✓ 5-year guarantee

CODE	EAN	SURFACE	MEASUREMENT (length in cm)	PERFORMANCE (in watt)	IP PROTECTION CLASS	WEIGHT (in kg)	CONNECTION
BHPIGH6070400	4260409690523	Glass Picture	60 x 70 x 2.5	400	IP44	8	1/N/PE ~ 230 V 50 Hz
BHPIGH6090500	4260051489810	Glass Picture	60 x 90 x 2.5	500	IP44	11	1/N/PE ~ 230 V 50 Hz
BHPIGH60120700	4260051489827	Glass Picture	60 x 120 x 2.5	700	IP44	14	1/N/PE ~ 230 V 50 Hz
BHPIGH60140500	4260409690547	Glass Picture	60 x 140 x 2.5	500	IP44	16	1/N/PE ~ 230 V 50 Hz



## IMAGE GLASS HEAT FRAMELESS IP44

FRAMELESS GLASS HEAT PANEL WITH MOTIF

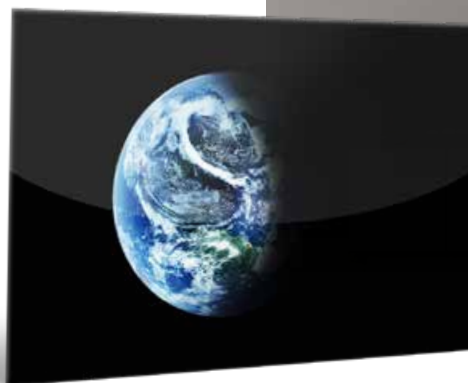

Highly elegant and stylish heat panel with a high gloss, heat-resistant image glass surface. You can choose from a wide range of images available in our database at [www.burdawtg.de/motive](http://www.burdawtg.de/motive), or opt for a custom image for an additional fee!

- ✓ Special glass with aluminum housing
- ✓ Frameless
- ✓ 2.5 cm deep
- ✓ With motif of your choice
- ✓ Protection Class IP44
- ✓ Heat dissipation at almost 100 % on the front
- ✓ Safety shut-down in case of overheating
- ✓ Comes with wall-mounting kit
- ✓ Includes 1.9 m cable and plug
- ✓ 5-year guarantee

CODE	EAN	SURFACE	MEASUREMENT (length in cm)	PERFORMANCE (in watt)	IP PROTECTION CLASS	WEIGHT (in kg)	CONNECTION
BHPIGHF6070400	4260409690554	Glass Picture	60 x 70 x 2,5	400	IP44	8	1/N/PE ~ 230 V 50 Hz
BHPIGHF6090500	4260409690561	Glass Picture	60 x 90 x 2,5	500	IP44	11	1/N/PE ~ 230 V 50 Hz
BHPIGHF60120700	4260409690585	Glass Picture	60 x 120 x 2,5	700	IP44	14	1/N/PE ~ 230 V 50 Hz
BHPIGHF60140500	4260409690592	Glass Picture	60 x 140 x 2,5	500	IP44	16	1/N/PE ~ 230 V 50 Hz



## MIRROR HEAT IP44 WITH ALUMINUM FRAME

MIRROR HEATER WITH FRAME



Very stylish and elegant-looking infrared heater with a surface made of high-gloss, heat-resistant, special-purpose glass. The mirror heating ensures non-fogging mirrors even after longer sessions in the bathroom.

- ✓ Special glass in an aluminum case
- ✓ aluminium frame, 15 mm
- ✓ 2.5 cm deep
- ✓ Non-tarnish mirror (in operation)
- ✓ Protection Class IP44
- ✓ Heat dissipation at almost 100 % on the front
- ✓ Safety shut-down in case of overheating
- ✓ Comes with wall-mounting kit
- ✓ Includes 1.9 m cable and plug
- ✓ 5-year guarantee

CODE	EAN	SURFACE	MEASUREMENT (length in cm)	PERFORMANCE (in watt)	IP PROTECTION CLASS	WEIGHT (in kg)	CONNECTION
BHPMH4060210	4260409690387	Mirror	40 x 60 x 2.5	210	IP44	5	1/N/PE ~ 230 V 50 Hz
BHPMH6070400	4260409690394	Mirror	60 x 70 x 2.5	400	IP44	7	1/N/PE ~ 230 V 50 Hz
BHPMH6090500	4260051489902	Mirror	60 x 90 x 2.5	500	IP44	10	1/N/PE ~ 230 V 50 Hz
BHPMH60120700	4260051489919	Mirror	60 x 120 x 2.5	700	IP44	13	1/N/PE ~ 230 V 50 Hz
BHPMH60140900	4260409690448	Mirror	60 x 140 x 2.5	900	IP44	14	1/N/PE ~ 230 V 50 Hz
BHPMH802001400	4260409690455	Mirror	80 x 200 x 2.5	1400	IP44	25	1/N/PE ~ 230 V 50 Hz



## MIRROR HEAT FRAMELESS IP44

MIRROR HEATER WITHOUT FRAME

Very stylish and elegant-looking infrared heater with a surface made of high-gloss, heat-resistant, special-purpose glass. The mirror heating ensures non-fogging mirrors even after longer sessions in the bathroom.



- ✓ Special glass in an aluminum case
- ✓ Frameless
- ✓ 2.5 cm deep
- ✓ Non-tarnish mirror (in operation)
- ✓ Protection Class IP44
- ✓ Heat dissipation at almost 100 % on the front
- ✓ Safety shut-down in case of overheating
- ✓ Comes with wall-mounting kit
- ✓ Includes 1.9 m cable and plug
- ✓ 5-year guarantee

CODE	EAN	SURFACE	MEASUREMENT (length in cm)	PERFORMANCE (in watt)	IP PROTECTION CLASS	WEIGHT (in kg)	CONNECTION
BHPMHF6070400	4260409690462	Mirror	60 x 70 x 2.5	400	IP44	7	1/N/PE ~ 230 V 50 Hz
BHPMHF6090500	4260051489872	Mirror	60 x 90 x 2.5	500	IP44	10	1/N/PE ~ 230 V 50 Hz
BHPMHF60120700	4260051489889	Mirror	60 x 120 x 2.5	700	IP44	13	1/N/PE ~ 230 V 50 Hz
BHPMHF60140900	4260409690516	Mirror	60 x 140 x 2.5	900	IP44	14	1/N/PE ~ 230 V 50 Hz





## BHCI868

Radio controlled thermostat INSTAT-868 - **230 V/16 A**

INSTAT-868, the radio-controlled thermostat by Eberle, serves as a temperature and time dependent switch of electrical devices such as fan heaters, circulation pumps, radiators, etc. in conjunction with an INSTAT switching unit. Operation is very simple. Among others, daily and weekly programmes can be set. Battery powered.

External control of indoor longwave heaters to comply with EU Regulation 2015/1188.

CODE

BHCI868

EAN

4260409690646



## BHCI868R1

Radio controlled thermostat INSTAT 868-R1 with analogue temperature setting - **230 V/16 A**

Wireless thermostat (transmits to receiver INSTAT 868-a ...) Easy operation via a single setting dials. Wireless temperature setback via the INSTAT 868r clock thermostat and two alternative control methods for compatibility with nearly all heating system types.

CODE

BHCI868r1

EAN

4260409690653



## BHCI868A1A

Receiver/switching unit INSTAT868-a1A - **230V/16 A**

Single channel radio controlled receiver as an additional receiver for INSTAT radio controlled thermostats. This device is the ideal surface-mounted solution and switches up to 16 A.

CODE

BHCI868a1A

EAN

4260409690660



## BHCI868UP

Receiver/switching unit INSTAT-868-UP - **230 V**

Additional receiver for INSTAT radio-controlled thermostats. This device is the ideal flush-mounted solution.

CODE

BHCI868UP

EAN

4260409690677



## BHCI868R1F

RF window contact INSTAT 868-r1F

Detects open windows in connection with flush-mounted receiver and switches the heater off for max. 30 minutes. Protection class: IP54, Dimensions: 65 x 12 x 28 mm, Power supply: Battery 3 V (CR 2030)

CODE

BHCI868r1F

EAN

4260409694750



## BHCI868A1S

Receiver/switching unit INSTAT 868-a1S - **230 V**

Universally usable for control of electric heaters, including electric radiators, electric wall heaters and electric heated towel rails. Easily installed by anyone, no electrical connection to the transmitter required (saves wiring and thus time-consuming cutting, installation, plastering and painting).

CODE

BHCI868a1S

EAN

4260409690684



## BHCRTTR-E 3311

Schuko socket thermostat – **230 V**

Room temperature regulator, surface-mounted, pure white unit. IP30, adjustable from 5 °C – 30 °C, 1.8 m cable and adapter, thermal feedback.

CODE

BHCRTTR-E 3311

EAN

4260409690684



## BHCITCTI

Socket thermostat with thermo-timer – **230 V/16 A**

Temperature and time dependent switching of electrical devices such as fan heaters, circulation pumps, radiators, etc. You can set daily and weekly schedules. Battery powered. 2-year guarantee.

CODE

BHCITCTI

EAN

4260409691001



## BHCINSTAT+3R

Radio-controlled thermostat – **230 V**

INSTAT-868, the radio-controlled thermostat by Eberle, serves as a temperature and time dependent switch of electrical devices such as fan heaters, circulation pumps, radiators, etc. in conjunction with an INSTAT switching unit. Operation is very simple. Among others, daily and weekly programmes can be set. Battery powered.

External control of indoor longwave heaters to comply with EU Regulation 2015/1188.

CODE

BHCINSTAT+3R

EAN

4260409690998



## BHCRTTR-E 9164

Temperature regulator for flush mounting – **230 V**

Room thermostat, surface or flush mounting, sophisticated design, bimetallic technology with thermal feedback and high precision. Easy-to-use clamps and a generous clamping frame and fast installation, IP30, adjustable from 5 °C to 30 °C.

CODE

BHCRTTR-E 9164

EAN

4260409690950



## BHCRTTR-E 3521

Two-wire thermostat – **230 V**

Temperature regulator, surface-mounted, pure white unit. IP30, adjustable from 5 °C to 30 °C.

CODE

BHCRTTR-E 3521

EAN

4260409690967



## BHCFIT3R

Digital socket thermostat – **230 V/16 A**

Pure white colour, flush-mounted. Temperature settings between 5°C – 30°C in increments of 0.5°C. Large display with backlighting at the touch of a button, user-friendly operation, pre-set and adjustable lifestyle programmes, wide range of custom programme settings, automatic switchover to summer/winter settings, protection against unauthorised access, holiday settings by date, frost control, energy consumption indicator.

External control of indoor longwave heaters to comply with EU Regulation 2015/1188.

CODE

BHCFIT3R

EAN

4260409690981



## BHPFG

T-Stand designed especially for the glass- and mirror-heater-models (2 pieces).

CODE

BHPFG

EAN

4260409690790

# Promotion



We will gladly advise you on start-up and language variants  
+49 6173/324 24 0

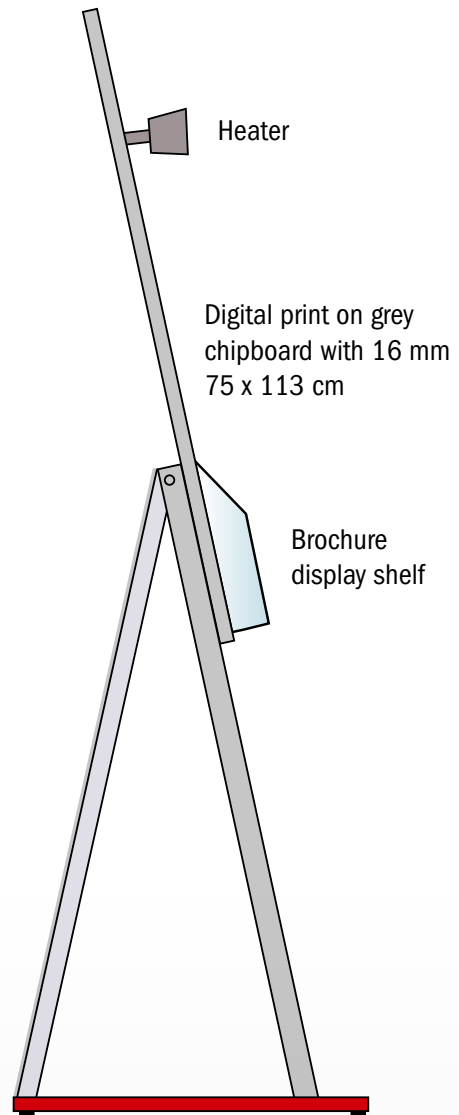

**YOU WILL BE INSPIRED BY THE INNOVATIVE INFRARED HEATER FROM BURDA.**

Convince your clients with intelligent comfortable heat at the push of a button. With this new professional display, guide the attention of your clients to our innovative heaters. The huge and instant heat output is most effective during this live demonstration.

A push-button timer and a display shelf for complimentary brochures is included.



# What is infrared?

## SUCCESS WITH THE INTELLIGENT TECHNOLOGY

Infrared short-wave technology: Infrared radiation is a sub-area of the light spectrum generated by the sun. This type of light, however, is invisible to the human eye; it only serves to radiate heat. Basically: the shorter the wavelength, the easier it is to penetrate the air. Short-wave infrared generates heat by heating the object it meets with, without heating the air around it. Even effective and instant heat without pre-heating. A good example for this mode of action is the effect that occurs when a person walks out of the shade into the sunlight. Although the ambient temperature remains the same, they feel the temperature as considerably warmer under direct solar radiation. Economically, environmentally convincing and cost-saving for more advantages.

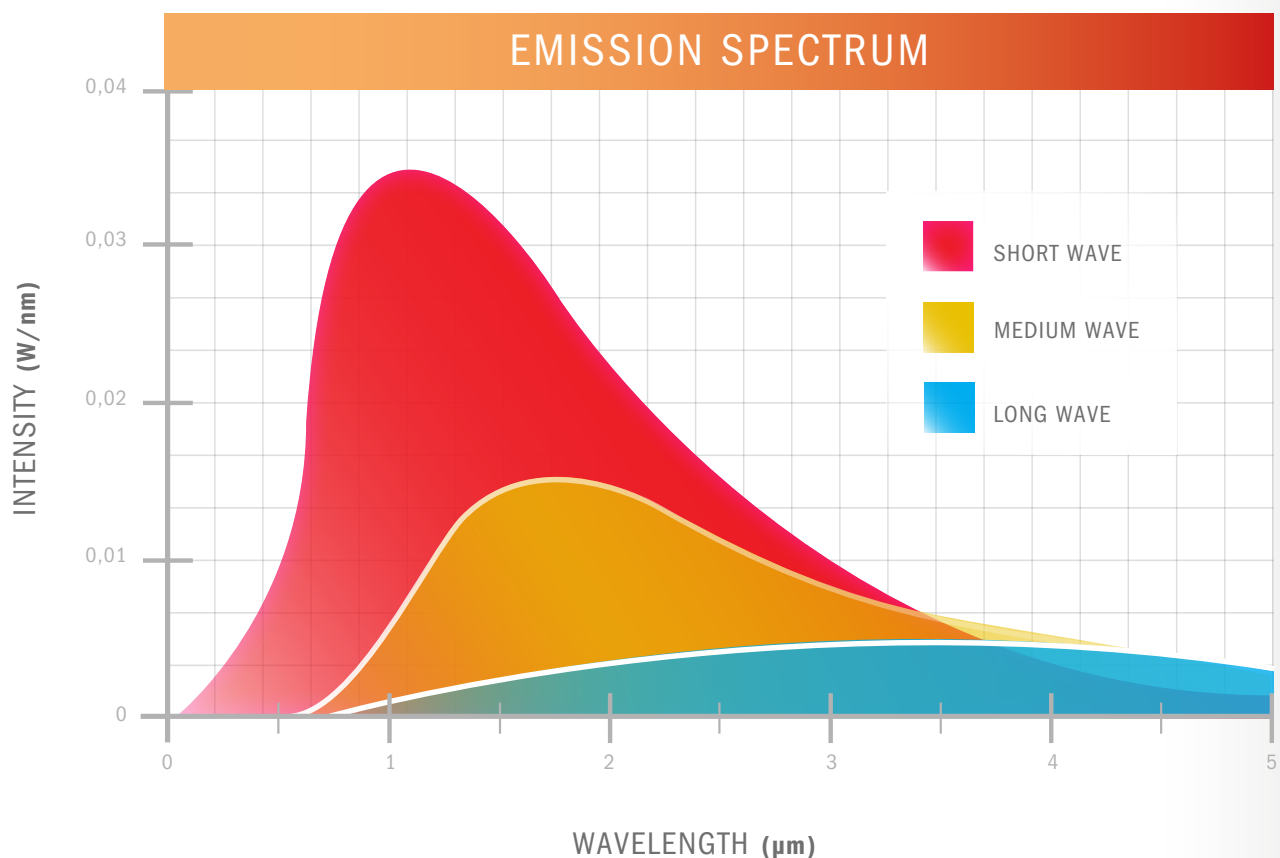

## CANDLE-LIGHT ATMOSPHERE WITH **ULTRA LOW GLARE HEATERS**

The **ULTRA LOW GLARE** heater series offers instant heat and an extraordinary candle-light atmosphere at the same time. The special coating of the lamps inside and outside filters and reduces light by 80 % without loss of heat. In that way it creates a very soft light source, which does not influence existing ambience illumination on terraces and other outdoor areas.



**ULTRA LOW GLARE** is available in the heater series TERM2000 IP24, IP65 and IP67 as well as for all PERFECTCLIME® heaters.

# Good to know

## TERM2000 HEAT FOOTPRINT WITH 45° INSTALLATION ANGLE

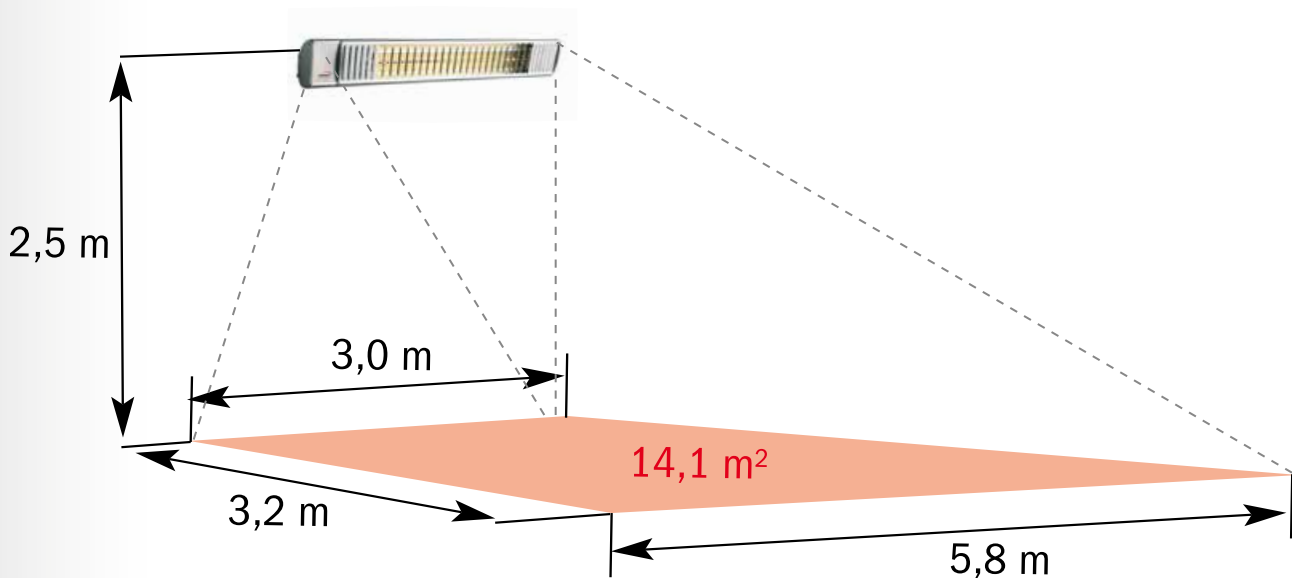

### GAS DEVICE

#### Short operation time

Traditional gas patio heaters use 11 kg gas bottles, which have to be changed after **8-11 hours**.

11 kg bottle propane gas: 20 €

Consumption 1 kg/h:  
**Cost per hour = 1.81 €**

### BURDA RADIANT HEATER

#### Long operation time

Infrared short-wave radiant heaters only need a new heating tube after **some 5,000 working hours**.

2,000 Watt power at current average price (2017)  
= 2 x 29 Cent:

2,000 W radiant heater:  
**Cost per hour = 0.58 €**

**Conclusion: Saving per hour  
= 1.23 € or more than 70%**

With same operating cost  
= 3-4 BURDA radiant heaters  
= 1 Gas patio heater

**Instant heat for 14-16 m<sup>2</sup> with 2000 Watt for Ø 58 Cent per hour**





Your dealer

## INTELLIGENT DECISIONS!

Our clients value the outstanding quality and the broad range of application of our products. Whether in the hotel or catering industry or in private areas the BURDA infrared short-wave technology heater and cooler product range convinces the world leading brands and industries (MS Europa, the best cruise liner in the world). Choose the intelligent solutions to your needs.

## SELECTION OF REFERENCES

### International Cooperation

- AEG/Stiebel Eltron
- Bartscher
- Schwank

### Worldwide first class hotels

- Adlon
- Holiday Inn
- Hilton
- Marriott
- Sheraton
- Steigenberger
- The Century
- Vier Jahreszeiten ...

### International and national restaurants and cafes

- Blockhouse Steakhäuser
- Burger King
- Cafetiero
- Häagen-Dazs
- Hard Rock Cafe
- Le Crobag
- McDonald's
- Nordsee
- Starbucks ...

### Superior grandhotel at sea

- AIDA Cruises
- A-Rosa Cruises
- Celebrity Cruises
- MS Europa (Das Traumschiff)

### TV-Studio

- Big Brother
- Endemol

### Museum and events

- Louvre Paris – France
- Berlinale Berlin – Germany

### Trade and industry

- Areva
- Ford
- Mercedes
- Thyssen Krupp
- Volkswagen ...

### Air Traffic

- Air Berlin
- Condor
- Lufthansa
- Royal Air Force
- US Army ...

## BURDA WORLDWIDE TECHNOLOGIES GMBH

Rudolf-Diesel-Strasse 18 · 65760 Eschborn · Germany  
 tel +49 6173 / 324 24 0 · fax +49 6173 / 324 24 24  
 email info@burdawtg.com · www.burdawtg.com



Visit our  
 MODULAR website  
[www.burdamodular.com](http://www.burdamodular.com)



Visit our  
 heatpanel website  
[www.heatpanels.com](http://www.heatpanels.com)



Visit our Heating &  
 Cooling website  
[www.perfectclime.com](http://www.perfectclime.com)



Visit our  
 American website  
[www.TheHeater.com](http://www.TheHeater.com)